

Mixed Flow Fans Belt and Direct Drive Models QEI, QEID



BUILDING VALUE IN AIR.



November
2016

Mixed Flow Fans

Mixed flow inline fans can be used for supply, exhaust, or return air installations. Our **patented** design excels in commercial applications where low sound is critical. In addition, Greenheck's mixed flow fans are more efficient than comparably sized tubular centrifugal and vane axial fans, thus reducing the required motor horsepower and lowering operating costs.

Greenheck's mixed flow fans are the quietest tubular inline fans in the industry!

- Performance as cataloged is assured. All sizes are licensed to bear the AMCA Certified Sound (both inlet and outlet) and Air Performance Seal.

UL/cUL Listed	QEI	QEID
705 - Electrical	✓	✓
Emergency Smoke Evacuation	✓	✓
762 - Restaurant Grease Exhaust	✓	

- All sizes are tested before they leave the factory to ensure trouble-free operation at the jobsite.
- Compact size and a "Universal Mounting System" make tight space considerations and last minute mounting changes easy to handle at the jobsite.
- The belt drive models use air handling quality bearings that are 100% inspected for swivel torque, noise levels, and bore tolerances.
- These products are subjected to extensive life cycle testing, assuring many years of reliable performance.

Typical Mixed Flow Applications:

Recommended for any ventilation application that requires low sound and high efficiency, such as office buildings, parking garages, concert halls, libraries, and educational facilities.



Greenheck Fan Corporation certifies that the model QEI and QEID shown herein are licensed to bear the AMCA Seal. The ratings shown are based on tests and procedures performed in accordance with AMCA Publication 211 and AMCA Publication 311 and comply with the requirements of the AMCA Certified Ratings Program.

For QEID performance showing AMCA licensed data for sound and air performance, please refer to the QEID Sound and Air Performance Supplement found on our website at www.greenheck.com.

Model QEI-I/II – Belt Drive

- 17 sizes available (9 thru 60)
- Two classes of construction
- Volume Range: 500 - 116,000 cfm (850 - 197,000 m³/hr)
- Static Pressure
Up to 5 in. wg (1245 Pa) Class I
Up to 8 in. wg (1990 Pa) Class II



Model QEID – Direct Drive

- 15 sizes available (12 thru 54)
- 50 - 100% wheel widths
- Volume Range: 700 - 88,000 cfm (1190 - 149,500 m³/hr)
- Static Pressure: Up to 10 in. wg (2490 Pa)



Patented (QEI/QEID): USA Patent No. 7048499
China (P.R.) Patent No. CN1294361C
Mexico Patent No. 243465

Housing

Tubular housings are constructed of welded steel to eliminate air leakage. Integral straightening vanes are constructed from steel and welded into place.

Wheel – Mixed Flow

Fabricated wheels are constructed from steel. The blade profiles are angled and contoured for the most efficient and quiet performance.

Bearings (Belt Drive)

Standard bearings are premium air handling quality, grease lubricated, self-aligning, ball or roller type. Bearings are selected with a basic rating fatigue life L_{10} per ABMA standards, in excess of 80,000 hours (L_{50} at 400,000 hours) at the maximum operating speed for the QEI-I/II in the horizontal position.

Bolted Access Door

A bolted access door provides an opening through the fan housing for cleaning or visual inspection of the wheel. A hinged access door is available as an accessory.

Belt Guard (Belt Drive)

A totally enclosed belt guard provides protection from rotating pulleys and belts. Belt guards meet OSHA Standards.

Slip-Fit Duct Connection

Inlets and outlets are designed with extended collars for slip-fit duct connections as standard.

Adjustable Motor Bases (Belt Drive)

Rigid, heavy-gauge steel motor bases are welded to the fan housing and include heavy-duty adjustment screws for belt tensioning.

Extended Lube Lines

Belt drive units have nylon lubrication lines with grease fittings that allow bearing lubrication without disassembling the fan. Grease fittings are mounted on the outside of the fan housing. Direct drive units have extended lubrication lines for the motor bearings, if required. Smaller frame sized motors are typically sealed and not lubricatable.

Permatec™ Coating

Greenheck's Permatec coating is a thermosetting polyester urethane, electrostatically applied to provide uniform thickness and a clean appearance. Permatec coatings also provide excellent corrosion characteristics for general applications, both indoor and outdoor. For corrosive environments (i.e. coastal), see page 9 for information on our zinc-rich basecoat technology.

Model Number Nomenclature

The model number code provides a numbering system designed to identify the fan model, size and horsepower.

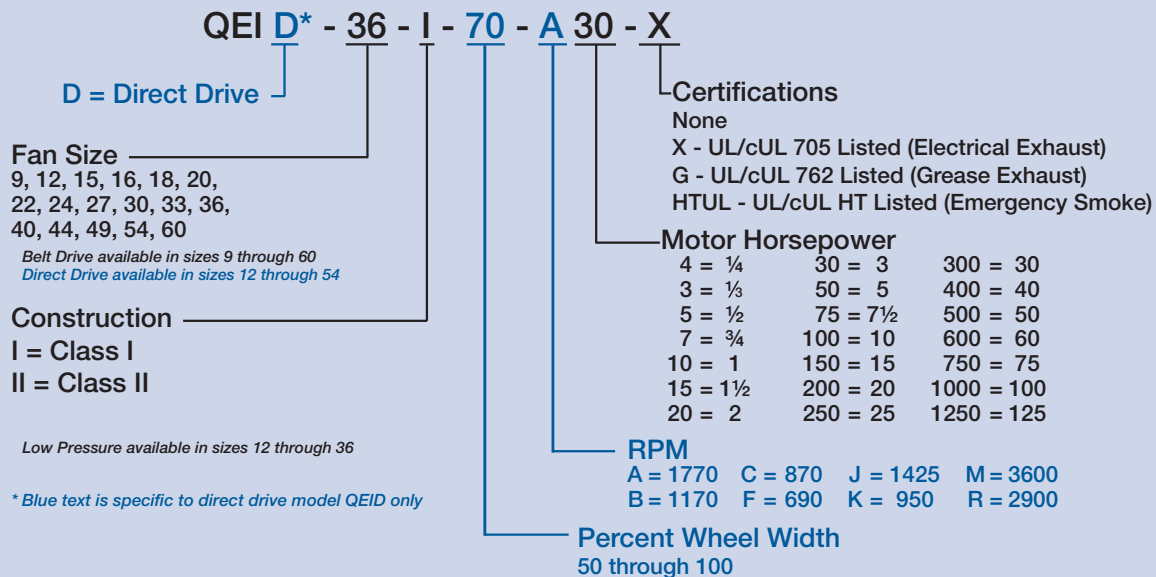

Quality Assurance Test

Before shipment, all Greenheck mixed flow fans are tested at the design speed after final assembly. QEI and QEID fans are checked for amp draw and the levels are recorded. QEI and QEID fans are also subjected to a complete vibration analysis. The maximum allowable vibration on a QEI at the fan bearings is 0.15 in/sec. peak velocity for the specified RPM. QEID maximum vibration is 0.08 in/sec.



peak velocity on the fan housing for the specified RPM. A record of the vibration test result is available upon request.

By performing the vibration test, we are able to provide more than wheel balancing, it is also a diagnostic tool for finding potential problems. A defective bearing or motor, bent shaft or misaligned sheaves may cause excessive vibration. A complete vibration test will uncover these problems before the fan leaves the factory.

Electrostatic Powder Coatings

Powder coatings offer a uniform, durable and high-quality finish. Standard powder coating is a one-coat process applied over a phosphatized surface that generally meets or exceeds the corrosion resistance of a comparable wet paint.



Greenheck offers a number of in-house coatings applied via "electrostatic powder." The standard coating, Permator™, is excellent for indoor or outdoor applications and is resistance to many common chemicals. Consult Greenheck's Product Application Guide, *Performance Coatings for Ventilation Products*, for a complete listing of coatings and a relative

resistance chart. For corrosive environments (i.e. coastal), see page 9 for information on our zinc-rich basecoat technology.

Maintenance / Serviceable Construction Advantages

The following value added features are incorporated into the design to allow for quick and easy field service.

QEI service advantages:

- Bearing lubrication is performed through extended grease fittings located on the outside of the fan housing.
- The entire shaft and bearing assembly can be removed as a single assembly from the inlet end of the fan housing.
- An adjustable motor base is provided for tightening the fan belts.

QEID service advantages:

- Extended lubrication lines are provided for motor bearing requiring lubrication. Smaller frame motors use sealed bearings and are permanently lubricated.



Inlet and Outlet Sound Power Levels

All Greenheck mixed flow fans have AMCA licensed sound power levels for both the fan inlet and outlet.

Application and installation determines which sound power reading (inlet, outlet, or both) is critical. The differences between the generated sound from the inlet and outlet are important and noticeable. AMCA licensed inlet and outlet sound power data provides complete sound information to select a fan based on the acoustical requirements. For additional information on sound, refer to page 6.



Greenheck's Sound Lab



Field Rotatable Housing / Compact Size

The QEI are designed to accommodate changing fan mounting positions and motor orientation in the field. Mounting fixtures are securely bolted to the fan casing and can be relocated to reposition how the fan is installed or the position the motor is oriented.

Flexibility in a motor's location is important for easier access and can determine where the unit will fit. Last minute design changes or unexpected obstacles during installation are no longer a problem.

Greenheck's mixed flow fans were designed for compact size. Keeping size to a minimum is important when fitting into tight spaces like mechanical rooms or air handlers.

Slip-Fit Duct Connections

The inlet and outlet ends of the QEI and QEID are designed to accept "slip-fit" connections. Often companion flanges are bolted to a fan's inlet/outlet flange to provide a slip-fit connection for a flexible sleeve. This extra step is now eliminated by directly attaching the flexible sleeve to the duct and fan. This saves time and money in the installation process.

It is recommended to use a flexible sleeve connection instead of a rigid duct connection.

The advantages of a flexible transition are:

- Decreased sound transmission in the ductwork
- Flexible connections allow for minor misalignment
- Accommodates the use of thrust restraints to resist thrust loads



Patented (QEI/QEID)

USA Patent No. 7048499
 China (P.R.) Patent No. CN1294361C
 Mexico Patent No. 243465

AutoCAD® and 3-D Revit® Models

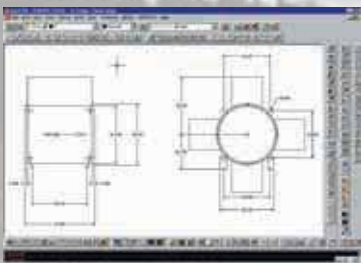

Scaled AutoCAD® drawings and Revit® models are available through Greenheck's website or from the Greenheck CAPS program which retrieves drawings and places them automatically into a job folder.



Mixed Flow: Axial/Centrifugal Hybrid

A mixed flow wheel is a hybrid between an axial propeller and a centrifugal wheel. The result is a design that combines the best axial and centrifugal properties: highly efficient air movement, increased pressure capabilities, extremely low sound levels, and a steep fan performance curve. To further enhance the fan's performance, straightening vanes are incorporated in the housing. These serve to convert swirling airflow into a straight axial flow with a resulting static pressure rise and energy savings.

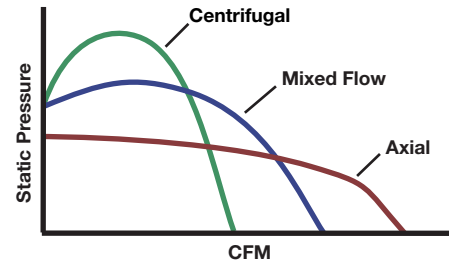

Airflow Profiles



Axial Fans: Straight through nearly linear airflow.

Centrifugal Fans: Two 90° deflections, before airflow exits the fan.

Mixed Flow Fans: Slight airflow deflection from straight through.

Sound and Efficiency

Sound power levels and fan efficiency are two very important factors when selecting a fan. There is a noticeable difference between impeller types. The table and chart below compare the sound power (L_{wA}) and the static efficiency of the belt-driven mixed flow fan wheel versus tubular centrifugal and vane axial inline fans. Over a wide range of operating points, the mixed flow fan provides the quietest and most efficient selection.

Performance	Mixed Flow Fan Size	Sound Power (L_{wA})			Static Efficiency		
		Mixed Flow (QEI-I/II)	Inline Centrifugal	Vane Axial	Mixed Flow (QEI-I/II)	Inline Centrifugal	Vane Axial
15,000 cfm @ 1.0 in. wg	24	90 dB	100 dB	103 dB	43%	17%	34%
25,000 cfm @ 2.0 in. wg	36	86 dB	93 dB	102 dB	68%	45%	56%
50,000 cfm @ 4.0 in. wg	49	92 dB	98 dB	111 dB	71%	60%	59%

Model comparisons based on similar outer tube diameters.

Lower Sound Power, Better Sound Quality

Sound power levels shown at each frequency:

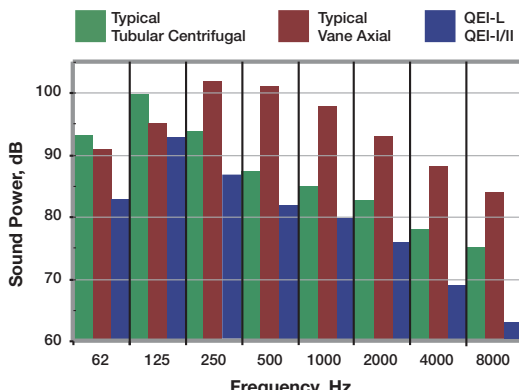

The sound quality of the belt-driven mixed flow fan line is as beneficial to low sound design as is the reduced overall sound power. The sound chart compares units of similar outer tube diameters at an operating point of 20,000 cfm with 1.5 inches wg of static pressure (Ps). Tubular centrifugals (green) have dominant tones in the 63 Hz through 250 Hz octave bands, while vane axials (red) have more mid to high frequency sound. The mixed flow fan (blue) does not have a dominant tone. A bystander would hear a more bland sound that is quieter than a tubular centrifugal or vane axial.

Belt Drive: Fan Class

Class I and II fans have different wheel designs with different performance characteristics.

Class I mixed flow wheels are optimized for performances involving low pressures and high volumes. Class II wheels are designed for a steeper fan curve with higher pressure capabilities. This is illustrated in the graph with the two different class wheels plotted at identical fan RPMs.

When selecting a mixed flow fan, it cannot be assumed that moving into a Class II fan will produce the same results as a Class I mixed flow fans.

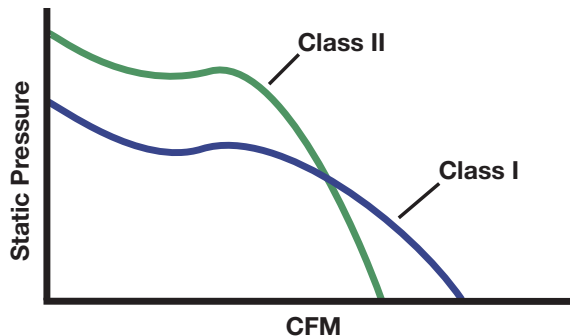

Direct Drive: Percent Wheel Width

Direct drive mixed flow fans are optimized for performance requirements by the use of partial width wheels. This is necessary because the fan RPM is commonly fixed and identical to the motor RPM. A reduction in the width of the wheel (or the air passage) results in reduced airflow capacity and a steeper fan curve. This is similar to the effect of a reduced pitch in a direct drive vane axial fan. QEID wheels are available in 5% increments from 50 - 100% wheel width.

QEID fans can be used in conjunction with variable frequency drives (VFD's) for variable air volume (VAV) systems. In these applications, the wheel width is optimized to ensure efficient operation and stable performance throughout the turndown range. VFD's are also used for final system balancing and to reduce the airflow when building requirements are reduced. In this case, the fan and wheel width are selected using the final design CFM and static pressure.

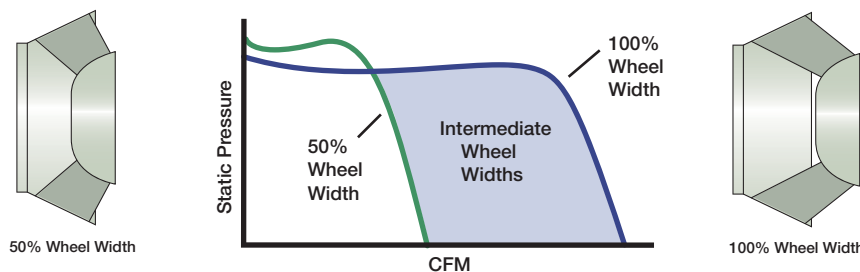

Sound Power versus Sound Pressure

The sound values displayed on the performance pages are in terms of inlet sound power (L_{WiA}) and outlet sound power (L_{WoA}). These values are the acoustic power radiating from the inlet and outlet of the fan, respectively. Sound pressure, expressed as dBA, is the acoustic pressure at a point in space which can be measured with a microphone or can be heard. To convert sound power (L_{WA}) into sound pressure (dBA), the following corrections are applied for a hemispherical free field.

$$dBA = L_{WA} - \text{correction}$$

Distance from Fan	3 ft. (0.9 m)	5 ft. (1.5 m)	10 ft. (3.0 m)
Correction	7 db	11.5 db	17.5 db

Note: Refer to AMCA Publication 303, Application of Sound Power Level Ratings for additional information on calculating typical sound pressure levels for fan installation.

Sure-Aire™

The Sure-Aire™ flow monitoring system measures fan flow within a 3% accuracy. Unlike traditional flow probes mounted in the fan venturi that create a system effect hindering fan performance, Sure-Aire™ does not interfere with airflow and will not impact the fan's air or sound performance. This option is available on all mixed flow fan models and ships completely assembled from our factory.

An electronics package with pressure transmitter and digital read out is available with the Sure-Aire™ system. The electronic kits are available for 50 or 60 Hz power supplies and provide either a 4-20 mA or 2-10 VCD output that can be tied into the building's automation system.



Sound Sensitive Areas

Sound Vault Housing - Radiated Sound Enclosure

The sound vault housing is an excellent product for fans that will be positioned adjacent to an occupied work space or in sound critical applications. It locks in radiated sound from the fan casing, motor and drives, and minimizes vibration transmission. Standard construction includes an acoustically lined housing, integral spring isolators, and internal flexible connections at the fan's inlet and outlet to effectively isolate the fan from the system. Horizontal mounting configurations are available.



Why use a Sound Vault?

- Sound power attenuation levels determined by sound intensity tests on actual units
- Ships fully assembled with fan
- Internal isolation to limit breakout noise
- Access panels for inspection of fan and motor
- Bearing lubrication lines extended to outside of enclosure
- Formed mounting rails with prepunched holes for easy installation
- Available on QEI-I through size 27 fans

This table lists the radiated sound reductions from total sound power levels for each octave band with the sound vault housing.

Center Frequencies [Hz]	63	125	250	500	1000	2000	4000	8000
Attenuation Value (dB)	13	20	25	31	34	35	36	36

In 1972, Greenheck took the lead as the first commercial and industrial fan manufacturer to introduce electrostatic powder coatings. Today, Greenheck continues to lead by being the first to offer a superior zinc-rich powder basecoat and powder coating finish.

This zinc-rich basecoat technology is used extensively outside the HVAC industry to protect bridge beams, automotive components and other heavy-gauge steel products. Now, this advanced technology is available on Greenheck welded steel products.

Greenheck's coating process starts with a minimum of five wash stages to treat all components prior to painting. Cleaner parts result in better coating adhesion and durability. We then use an advanced two-coat powder application method that includes a basecoat of zinc-rich powder and a topcoat of Greenheck's Permator™ or Hi-Pro Polyester. The combination of these two topcoats over the zinc-rich basecoat results in the two-coatings, Perma-Z and Hi-Pro-Z. These oven-cured coatings provide superior corrosion resistance along with a tough, uniform finish to combat the most extreme conditions.

Zinc Advantage

When compared to a traditional single coat application, the benefits of the two-coat system include:

- An automatic powder coat application that produces uniform coverage and unmatched paint quality.
- A double coat thickness that provides superior durability and protection from air and water.
- A zinc-rich basecoat that includes an epoxy component that provides additional corrosion protection.
- A zinc-rich basecoat that provides chemical protection of exposed steel to prevent corrosion.

The protection offered by the zinc-rich basecoats in Perma-Z and Hi-Pro-Z result in extraordinary corrosion resistance. Test data demonstrates our two-coat paint system offers three (Perma-Z) and four (Hi-Pro-Z) times the corrosion resistance of other coatings commonly available within the fan industry. See table for salt spray life for various coatings.

Coating fans with Perma-Z or Hi-Pro-Z has reduced our customers annual paint maintenance costs by three to four times!

For more information, see Greenheck's Coatings for Extreme Applications catalog, available online at www.greenheck.com

One Coat Process



Two-coat Process

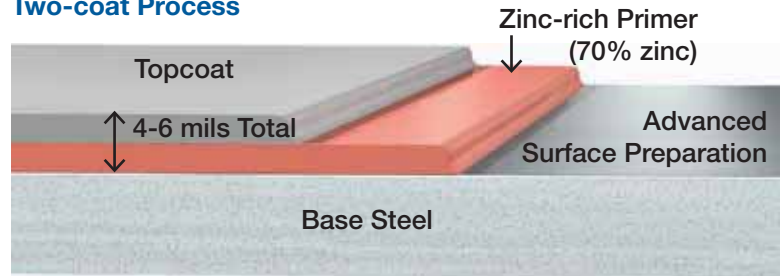

Salt Spray ASTM B117				
Hours	1000	2000	3000	4000
Permator™	██████████			
Hi-Pro Poly	██████████			
Perma-Z	██████████	██████████		
Hi-Pro-Z	██████████	██████████	██████████	
Baked Phenolic	██████████			
Epoxy Phenolic	██████████			
Fluorocarbon	██████████			

Salt Spray ASTM B117 is a comparative test that indicates the corrosion resistance of powder paint coatings.

Seismic Certification

The International Building Code (IBC) has been adopted at the state and local level throughout the United States. With the adoption of this code, comes the introduction of standards intended to improve the performance and design of non-structural systems subject to seismic events.

QEI and QEID

- Meet the 2006 IBC, 2009 IBC
- California OSHPD requirements (horizontal mount only) OSP 0223-10
- Shake table tested at an independent test facility in accordance with ICC-ES AC 156
- All equipment certified to worst case scenario seismic conditions
 - Importance factor of 1.5 (IP = 1.5)
 - Occupancy Categories (I - IV)
 - Site Classes (A - F)
 - Seismic Design Categories (A - F)

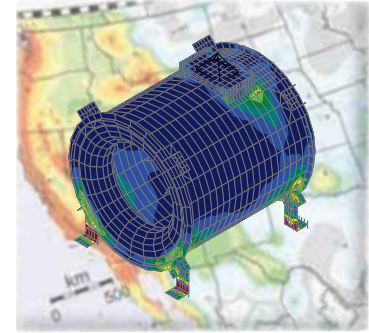

Structural Finite Element Analysis
Seismic Design Category F

Consult your Greenheck representative or visit greenheck.com/seismic for more details.

UL 705 Power Ventilator

QEI and QEID models are available with the UL/cUL 705 (Underwriters Laboratory) listing on a wide variety of 50 and 60 Hz motors. This listing ensures the use of UL approved electrical components.

Motors are available as either IEC (IP55) or NEMA (TEAO or ODP) designs. IEC design motors are adjustable speed drive (ASD) compatible, have class F insulation and are capable of wye-delta starting when over 5.5 kW. NEMA motors use across the line starting with options for ASD compatibility. Motor (IEC or NEMA) using 50 Hz power have a 1.0 service factor, while 60 Hz power have 1.15 service factor. Design and construction options for motors include increased thermal insulation, overload protection and extended motor leads.

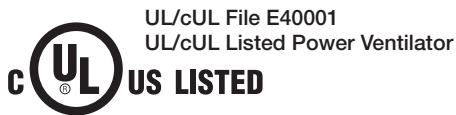

UL Emergency Smoke Evacuation

QEI and QEID models were tested and rated for design time and temperature used in emergency heat and smoke exhaust applications.

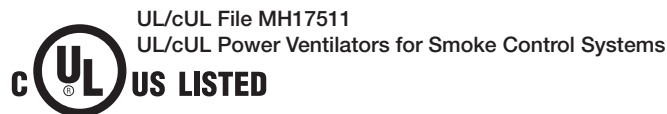

Model	Operating Temperature		Time Duration	Comments
	°C	°F	Hours	
QEID	300	572	1	Per British Spec 7346
QEI	300	572	2	
QEI	260	500	4	Per Industrial Risk Insurers (North America)
QEID	260	500	5	

Consult your Greenheck representative for time and temperature combinations other than those listed.

UL 762 Restaurant Exhaust

Inline grease exhaust fans are an excellent alternative for kitchen applications when roof or wall mounted ventilators are not practical. A QEI with UL 762 grease option is designed to withstand the demands of high temperature kitchen grease exhaust and high-pressure duct washers.

A Tough Package to Beat

The QEI inline grease fan is tough to beat when packaged with our full line of kitchen hoods and grease extraction options. Take advantage of Greenheck's expertise in providing a total solution in kitchen ventilation equipment.



UL 762 is concerned with fans designed for removal of smoke and grease laden vapors with airstream temperatures up to 400°F.

- Meets all UL 705 requirements
- UL/cUL File MH1745
UL/cUL Power Ventilators for Restaurant Exhaust Appliances
- Bolted access door
- Drain connection
- Meets requirements of NFPA 96 Ventilation Control and Fire Protection of Commercial Cooking Operations

Belt Drive Advantages

- Lower sound levels
- Motor out of the airstream for easy access
- Motor size may be changed to accommodate possible future air capacity requirements
- Final system balancing accomplished by changing drives



Direct Drive Advantages

- Fewer wear components and less maintenance, no shaft, bearings, pulleys, or belts
- More compact than equivalent belt drive size
- Motor in airstream for increased motor efficiency and cooling
- Equal loading between mounting brackets
- Final system balancing accomplished by adjusting the motor speed (ex. variable frequency drive use).

High Efficiencies = Lower Operating Costs

Example of Annual Operating Cost Savings

For a system performance requirement of 25,000 cfm at 2.5 inches of static pressure (wg) the corresponding operating power requirements are 13.97 Bhp with a QEI-I size 36 and 19.8 Bhp for a size 36 tubular centrifugal fan.

Formulas:

- Kilowatt-Hours = (Operating Power (Bhp) x 0.746 x Hours of Operation) / Motor Efficiency

- Operating Cost = Kilowatt-Hours x Power Cost per kW hour

Assumptions:

- Cost of electricity is \$0.09 per kilowatt hour

- 3,120 annual hours of operation (12 hours per day, five days a week, 52 weeks a year)

- 93.0% motor efficiency (equal to NEMA Premium minimum efficiency for 15 and 20 hp, ODP, 1725 rpm motor)

Tubular Centrifugal Fan

kW-Hours = (19.8 Bhp x 0.746 x 3120) / 0.93 = 49,554

Operating Cost = 49,554 x \$0.09 = \$4,460

QEI-I - Mixed Flow Fan

kW-Hours = (13.97 Bhp x 0.746 x 3120) / 0.93 = 34,963

Operating Cost = 34,963 x \$0.09 = \$3,147

Annual Operating Cost Savings = \$4,460 - \$3,147 = \$1,313

QEI Sizes 9-27



Fig. 1

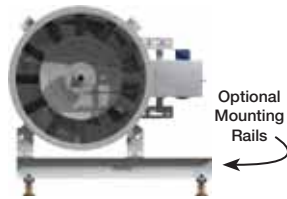

Fig. 2



Fig. 3

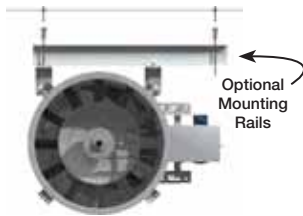

Fig. 4

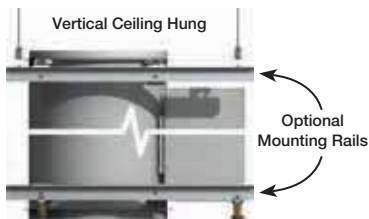

Fig. 5

Universal Mounting

QEI models sizes 9-27 can be mounted horizontally or vertically. For ease of installation, eight mounting brackets are welded on each fan. These eight brackets along with standard mounting supports provide for Greenheck's Universal Mounting System. **Motor positions are viewed from the discharge end.**

Fig. 1 Horizontal Base Mount

Each fan is shipped as standard in this arrangement. Motor at "A" position (12 o'clock) is standard.

Fig. 2 Horizontal Base Mount with motor at "C" or "G" position

A set of optional mounting rails are recommended for this installation.

Fig. 3 Horizontal Ceiling Hung

In this installation the supports can be positioned for mounting the motor at "A" or "E" (12 or 6 o'clock).

Fig. 4 Horizontal Ceiling Hung with motor at "C" or "G" position

A set of optional mounting rails are recommended for this installation.

Fig. 5 Vertical Mount

Universal QEI fans can be mounted vertically (ceiling hung or base mount) for either upward or downward airflow. Optional mounting rails are suggested for any vertical installation.

QEI Sizes 30-60

QEI models 30-60 are available in horizontal and vertical mounting configurations. *Lifting lugs are provided on horizontal fans for ease of installation. Vertical units should be lifted by the mounting brackets.*

Horizontal Mounting

Horizontal mounting configurations, base mount or ceiling hung, are provided with an identical support. The mounting configuration can be changed between base mount or ceiling hung in the field. The motor position can also be field rotated to any of the shown positions. **Motor positions are viewed from the discharge end.**

Base Mount: Rigid steel base provides stable mounting to floor for the housing.

Motor Positions: A, B, C, G and H

Ceiling Hung: Suspend the fan horizontally from the ceiling.

Motor Positions: A, C, D, E, F and G

Mounting rails are recommended for horizontal installations with B, C, D, F, G and H motor positions.

Vertical Mounting

Vertical mounting configurations, upblast or downblast, are provided with heavy duty steel brackets welded to both ends. These brackets permit either floor or ceiling mounting on the same unit. Optional mounting rails are suggested for any vertical installation for sizes 9-27.

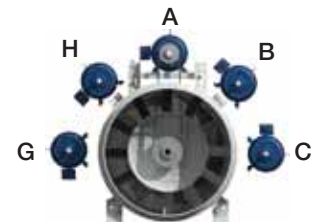

Horizontal - Base Mount

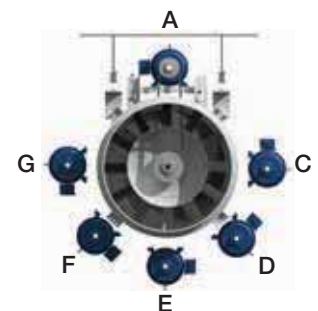

Horizontal - Ceiling Hung

Roof Upblast

Models QEI sizes 9 through 54 are available in roof upblast configuration. The roof upblast configuration is ideal for exhausting contaminants away from a building to prevent roof damage and re-entrainment of exhaust air. QEI roof upblast models have the high temperature UL rating and can be used for emergency smoke exhaust applications.

Standard construction includes a fully-welded heavy-gauge curb cap to eliminate leaks, a butterfly damper section for backflow prevention, and a windband section to protect the butterfly dampers from debris. A complete line of roof curbs is available for mounting to a roof deck.



Spark Resistant Construction

Greenheck mixed flow fans are available with spark resistant designs suitable for applications that involve flammable particles, fumes or vapors. Spark resistant construction options adhere to guidelines defined within AMCA Standard 99-0401-10.

QEI	Spark B	The fan wheel is constructed of a nonferrous material (aluminum). A non-ferrous (aluminum) bearing cover surrounds the driven bearing, shielding it from the airstream.
QEI	Spark C	The inlet cone is constructed of non-ferrous material (aluminum). A nonferrous (aluminum) bearing cover surrounds the driven bearing shielding it from the airstream.



		Availability		
		QEI-I	QEI-II	QEID
Motor Cover	A weatherproof motor cover shields the motor components from dust, dirt and moisture for indoor or outdoor installations. Motor covers also serve as a personnel guards and meet OSHA standards.	✓	✓	
Hinged Access Door	Hinged access doors provide an opening through the fan housing for cleaning or visual inspection of the wheel. Bolted access door is standard.	✓	✓	✓
Extended Life Bearings	Air handling quality, flange mounted bearings meet a basic rating fatigue life L ₁₀ per ABMA standards, in excess of 200,000 hours (L ₅₀ at 1,000,000) at maximum operating speed.	✓	✓	
Copper Lube Lines (Belt Drive)	Copper lube lines can be used as a replacement for standard nylon lube lines.	✓	✓	
Flanges	Inlet and outlet flanges with prepunched holes, welded to the housing, provide an easy means for bolted connection to ductwork. Matching bolt-on companion flanges are also available.	✓	✓	✓
Disconnect Switches	<p>Toggle-type and heavy-duty disconnect switches are available for positive electrical shut-off and safety when servicing fans. The following switches are available to meet individual electrical requirements and can be factory mounted or shipped loose for field mounting.</p> <ul style="list-style-type: none"> • NEMA-3R Rainproof • NEMA-4, 4X Watertight • NEMA-7 & 9* Class 1 and 2 hazardous locations <p><i>*Greenheck will not factory mount NEMA-7 & 9 disconnect switches.</i></p>	✓	✓	✓
Inlet and Outlet Guards	Removable inlet and outlet guards provide protection for personnel and equipment in ducted or non-ducted installations.	✓	✓	✓
Extended Wiring	Electric leads from the motor junction box are brought out to exterior of unit. This provides an easy means of connecting the motor to the electrical system.			✓
Belt Tube	A totally enclosed belt tube isolates the belts and drives from the airstream.	✓	✓	
Sound Vault Housing	See page 8 for more details on sound vault housing.	✓		
Mounting Rails	Mounting rails are recommended for vertically mounted fans or horizontal mounting when the motor is to be located in the C or G (3 or 9 o'clock) position.	✓	✓	
Isolators	Both base mount and hanging isolators are available in either neoprene or spring mounts.	✓	✓	✓
Special Coatings	Special coatings are available for protective purposes. Consult Greenheck's Product Application Guide, <i>Performance Coatings for Ventilation Products</i> , for a complete list of coatings available and their chemical resistance. Available online at www.greenheck.com .	✓	✓	✓
Sure Aire™ Flow Measurement	Sure-Aire provides real-time flow measurement for use in building automation systems. For additional information, see page 8 or our Sure-Aire Flow Monitoring System catalog available at www.greenheck.com .	✓	✓	✓



The quick select charts below and on the following page are a convenient method for sizing the fan required for a specific performance. Colored bands for a given size in each chart represent the entire operating range available for that size and speed.

For QEID performance pages showing AMCA Licensed data for sound and air performance please refer to the Model **QEID Sound and Air Performance Supplement** found at www.greenheck.com

1770 RPM (60 Hz)

Model QEID
12–33

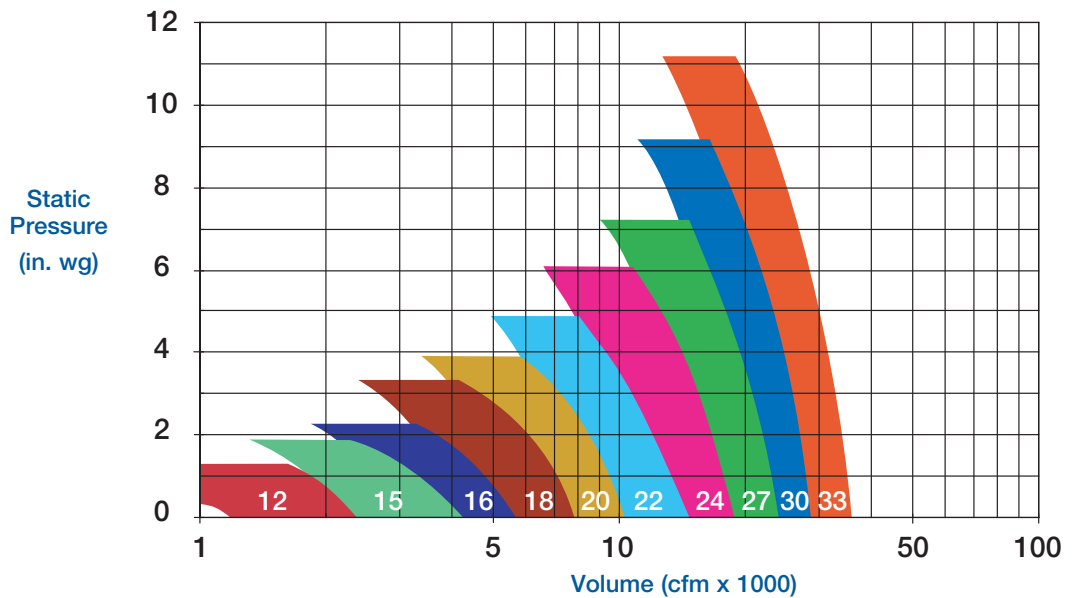

1170 RPM (60 Hz)

Model QEID
15–49

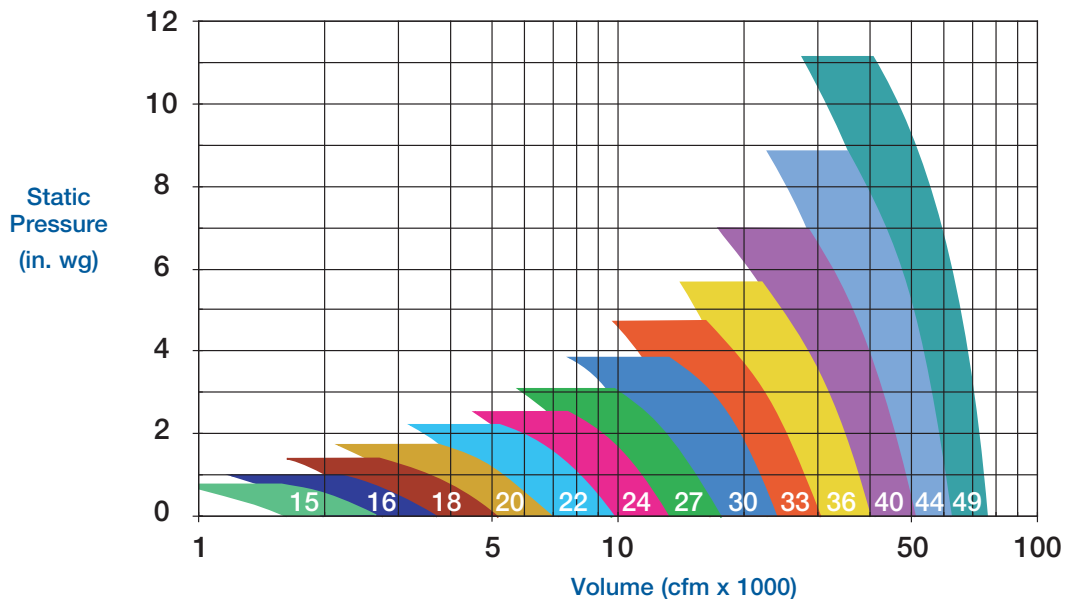

**870 RPM
(60 Hz)**

Model QEID
36–54

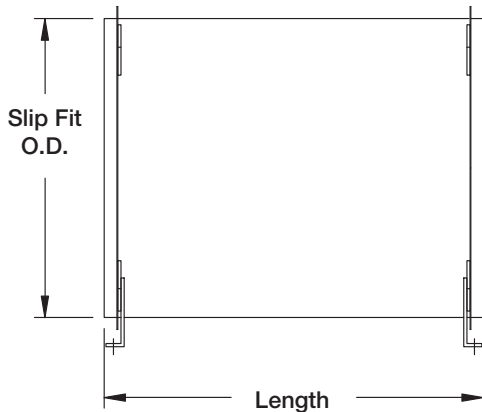
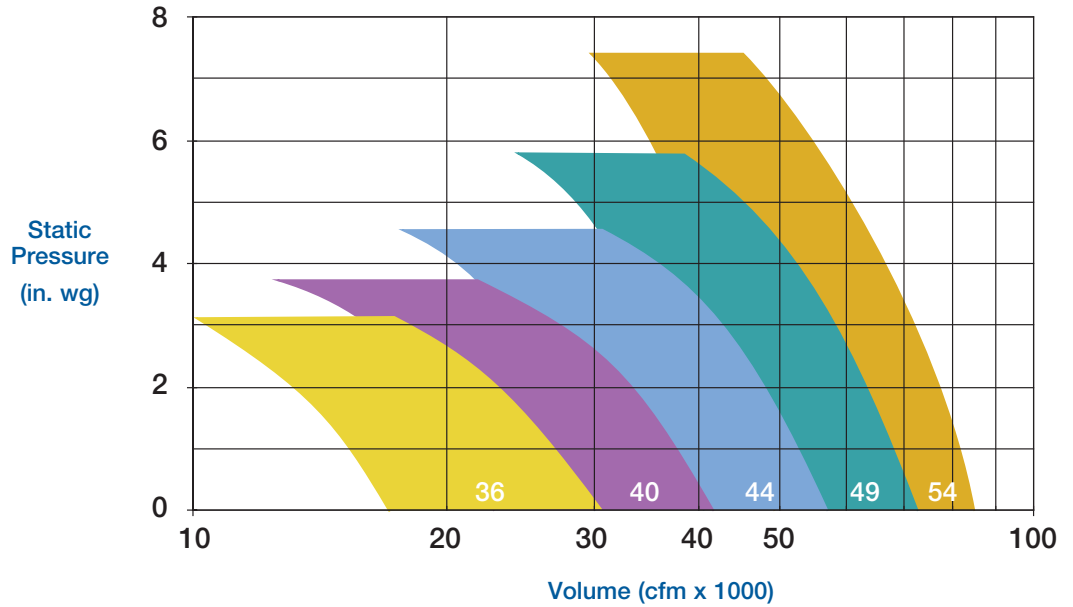

*Length varies with motor frame size. Refer to Length table shown.

**Weight is for unit only and does not include motor.

Size	Slip Fit O.D.		Length*		Weight**	
	inches	mm	inches	mm	lbs.	kg.
12	17.13	435	25.0	635	100	45
15	20.88	530	25.0	635	140	65
16	23.00	584	26.0	660	170	80
18	25.38	645	29.0	737	200	95
20	27.81	706	34.0	864	250	115
22	30.88	784	35.5	902	370	170
24	34.00	864	41.5	1054	480	220
27	37.44	951	45.0	1143	570	260
30	41.63	1057	Refer to table below.		860	390
33	45.75	1162			1140	520
36	50.56	1284			1360	620
40	55.75	1416			1650	750
44	61.63	1565			2190	995
49	67.75	1721			2700	1225
54	75.00	1905			3130	1420

Length — inches (millimeters)						
Size	254/6 T	284/6 T	324/6 T	364/5 T	404/5 T	444/5 T
30	45.5 (1156)	50.0 (1156)	50.0 (1156)			
33	46.5 (1181)	54.0 (1372)	54.0 (1372)	54.0 (1372)		
36	50.5 (1283)	58.0 (1473)	58.0 (1372)	58.0 (1372)		
40		56.5 (1435)	61.0 (1549)	61.0 (1549)		
44			64.0 (1626)	64.0 (1626)	70.0 (1778)	
49				74.5 (1892)	74.5 (1892)	80.5 (2045)
54				77.0 (1956)	77.0 (1956)	83.0 (2108)

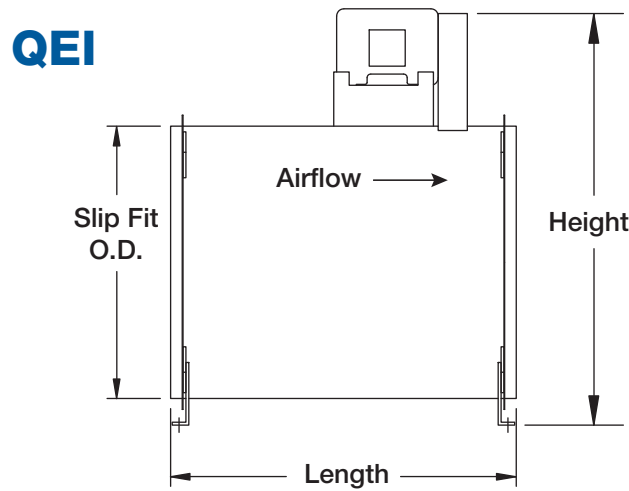

Size	QEI Class I		QEI Class II		
	Slip-Fit O.D.	Length	Height	Length	Height
	inches (mm)	inches (mm)		inches (mm)	
9	17.13 (435)	NA	NA	28.5 (724)	36.5 (927)
12	17.13 (435)	28.5 (724)	36.5 (927)	30.5 (775)	36.5 (927)
15	20.88 (530)	31.0 (787)	41.0 (1041)	34.0 (864)	41.0 (1041)
16	23.00 (584)	33.0 (838)	44.0 (1118)	34.0 (864)	44.0 (1118)
18	25.38 (645)	35.0 (889)	46.5 (1181)	39.5 (1003)	47.5 (1207)
20	27.81 (706)	37.5 (953)	50.5 (1283)	41.5 (1054)	50.5 (1283)
22	30.88 (784)	41.0 (1041)	53.5 (1359)	44.0 (1118)	53.5 (1359)
24	34.00 (864)	44.5 (1130)	57.5 (1461)	49.0 (1245)	59.5 (1511)
27	37.44 (951)	47.0 (1194)	61.0 (1549)	53.0 (1346)	63.0 (1600)
30	41.62 (1057)	54.0 (1372)	65.0 (1651)	60.5 (1537)	72.0 (1829)
33	45.75 (1162)	58.5 (1486)	69.0 (1753)	65.0 (1651)	76.5 (1943)
36	50.56 (1284)	64.0 (1626)	75.0 (1905)	69.0 (1753)	82.5 (2096)
40	55.75 (1416)	68.5 (1740)	83.0 (2108)	75.5 (1918)	90.5 (2299)
44	61.62 (1565)	74.0 (1880)	89.5 (2273)	80.5 (2045)	97.0 (2464)
49	67.75 (1721)	80.5 (2045)	96.5 (2451)	86.5 (2197)	104.0 (2642)
54	75.00 (1905)	87.0 (2210)	105.0 (2667)	93.5 (2375)	111.0 (2819)
60	82.88 (2105)	91.5 (2324)	113.0 (2870)	102.5 (2604)	119.0 (3023)

Performance Data		
Maximum Fan RPM	4000	
Specification Data		
Maximum Motor Frame Size	184T	
Minimum Motor Starting hp	1/3 hp	.25 kW
Wheel Diameter	15 in.	381 mm
Approximate Weight (Less Motor & Drives)	170 lbs.	77 kg.
Maximum Bhp = (Fan RPM / 2671) ³		
Outlet Velocity (FPM) = CFM / 1.56		
Tip Speed (FPM) = Fan RPM x 3.93		
% WOV = (CFM x 100) / (Fan RPM x 0.73)		

Imperial data — *Metric data*

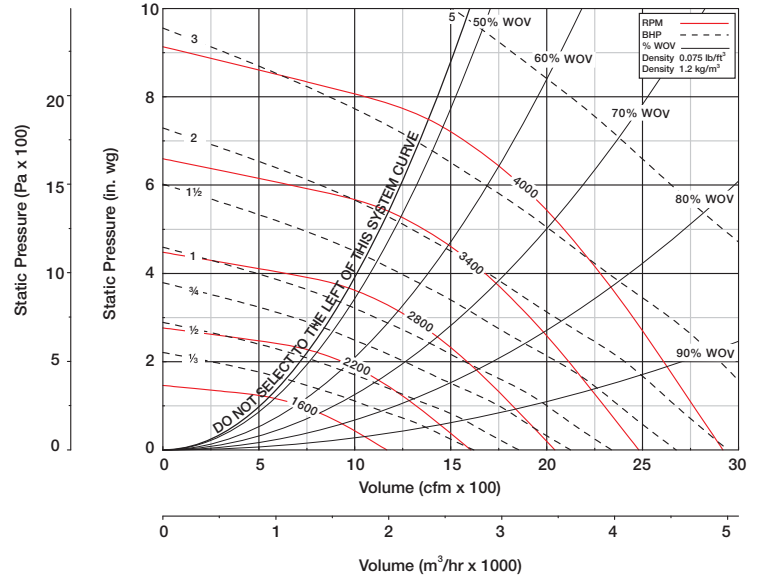

Performance Data

CFM	OV	STATIC PRESSURE (inches wg)																	
		0.25		0.5		1		1.5		2		2.5		3		3.5		4	
		RPM	BHP	RPM	BHP	RPM	BHP	RPM	BHP	RPM	BHP	RPM	BHP	RPM	BHP	RPM	BHP	RPM	BHP
850	541	1325	0.09	1463	0.14	1709	0.25	1937	0.38	2148	0.52	2341	0.67						
1000	636	1511	0.13	1633	0.18	1854	0.31	2056	0.44	2252	0.59	2432	0.75	2606	0.93	2767	1.11		
1150	732	1700	0.17	1811	0.23	2013	0.37	2198	0.52	2371	0.68	2542	0.85	2700	1.03	2858	1.22	3007	1.42
1300	828	1893	0.23	1994	0.29	2177	0.44	2349	0.61	2511	0.78	2661	0.96	2817	1.15	2961	1.35	3098	1.56
1450	923	2088	0.31	2181	0.37	2351	0.53	2510	0.71	2658	0.89	2804	1.08	2940	1.28	3079	1.49	3212	1.71
1600	1019	2285	0.40	2371	0.47	2530	0.63	2674	0.82	2818	1.02	2951	1.23	3083	1.44	3207	1.66	3331	1.88
1750	1114	2483	0.50	2563	0.58	2711	0.75	2849	0.95	2981	1.16	3109	1.38	3230	1.61	3351	1.84	3466	2.08
1900	1210	2682	0.63	2757	0.72	2897	0.89	3027	1.10	3149	1.32	3271	1.56	3387	1.80	3498	2.04	3611	2.29
2050	1305	2883	0.77	2952	0.87	3084	1.06	3207	1.26	3324	1.50	3435	1.75	3549	2.00	3656	2.26	3758	2.53
2200	1401	3083	0.94	3149	1.04	3274	1.25	3390	1.45	3502	1.70	3609	1.96	3713	2.22	3818	2.50	3918	2.78
2350	1496	3285	1.13	3347	1.24	3465	1.46	3576	1.68	3683	1.92	3785	2.19	3883	2.47	3981	2.76		
2500	1592	3487	1.34	3545	1.46	3657	1.69	3764	1.93	3865	2.16	3964	2.44						

Inlet Sound Power, L _{Wi} [dB ref 10 ⁻¹² watts]										
RPM	% WOV	1	2	3	4	5	6	7	8	L _{WiA}
1600	100	69	71	74	70	71	67	65	57	75
	80	71	69	72	68	68	66	62	56	73
	60	70	70	71	66	63	65	61	55	71
	50	72	70	71	65	63	65	61	55	71
2200	100	74	75	78	75	74	71	65	80	
	80	72	71	73	72	71	66	60	77	
	60	73	72	74	70	69	70	66	60	76
	50	75	73	74	70	69	70	66	61	76
2800	100	77	78	82	78	80	79	75	74	85
	80	77	78	77	74	75	71	66	81	
	60	78	79	78	74	74	70	65	80	
	50	78	79	79	75	74	70	65	80	
3400	100	78	80	84	80	83	83	79	79	89
	80	78	81	81	77	79	75	71	84	
	60	80	82	81	77	78	74	70	84	
	50	80	82	82	79	78	74	70	84	
4000	100	78	82	85	82	87	83	83	92	
	80	79	83	84	81	83	83	79	76	88
	60	82	85	84	80	82	81	78	76	87
	50	82	84	85	83	82	82	78	75	88

Outlet Sound Power, L _{Wo} [dB ref 10 ⁻¹² watts]										
RPM	% WOV	1	2	3	4	5	6	7	8	L _{WoA}
1600	100	76	78	78	70	71	65	63	56	76
	80	77	80	77	67	68	63	58	56	74
	60	80	78	76	66	66	62	58	56	73
	50	82	78	77	66	66	62	58	56	73
2200	100	86	86	84	77	78	74	69	64	82
	80	86	85	84	73	74	70	65	61	80
	60	87	85	82	73	73	69	65	61	79
	50	88	86	82	74	73	69	65	61	79
2800	100	88	85	87	81	83	80	75	72	87
	80	87	88	85	77	79	76	71	66	84
	60	91	85	86	78	78	75	70	67	84
	50	92	86	86	79	79	75	70	67	84
3400	100	88	88	91	84	87	85	80	78	92
	80	90	88	89	80	83	81	76	71	88
	60	94	87	89	82	83	80	76	72	88
	50	94	88	89	83	84	81	76	72	89
4000	100	88	93	96	87	91	90	85	83	96
	80	94	86	92	82	87	86	81	75	92
	60	95	89	92	85	86	85	81	76	92
	50	95	90	92	86	88	85	81	77	92

Performance certified is for installation type B: Free inlet, Ducted outlet. Power rating (Bhp) does not include transmission losses. Performance ratings do not include the effects of appurtenances (accessories).

The sound power level ratings shown are in decibels, referred to 10⁻¹² watts, calculated per AMCA Standard 301. Values shown are for inlet L_{Wi}, L_{WiA} and outlet L_{Wo}, L_{WoA} sound power levels for installation type B: Free inlet, Ducted outlet. Ratings for inlet sound do not include the effects of duct end correction. Ratings for outlet sound include the effects of duct end correction. The A-weighted sound power ratings shown have been calculated per AMCA Standard 301. The AMCA Certified Ratings Seal applies to L_{WiA} and L_{WoA} values only.

Performance Data		
Maximum Fan RPM	3800	
Specification Data		
Maximum Motor Frame Size	184T	
Minimum Motor Starting hp	1/3 hp	.25 kW
Wheel Diameter	15 in.	381 mm
Approximate Weight (Less Motor & Drives)	160 lbs.	73 kg.
Maximum Bhp = (Fan RPM / 2301) ³		
Outlet Velocity (FPM) = CFM / 1.56		
Tip Speed (FPM) = Fan RPM x 3.93		
% WOV = (CFM x 100) / (Fan RPM x 1.34)		

Imperial data — Metric data

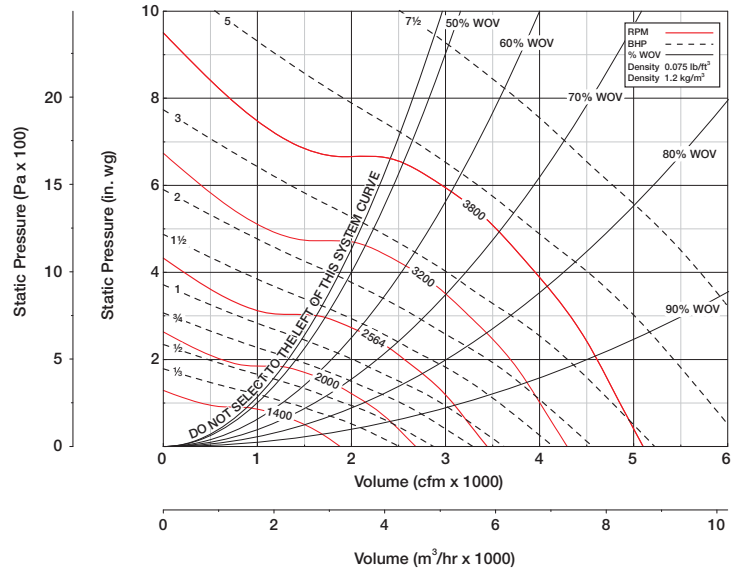

Performance Data

CFM	OV	STATIC PRESSURE (inches wg)																	
		0.25		0.5		1		1.5		2		2.5		3		3.5		4	
		RPM	BHP	RPM	BHP	RPM	BHP	RPM	BHP	RPM	BHP	RPM	BHP	RPM	BHP	RPM	BHP	RPM	BHP
1200	764	1070	0.09	1241	0.15	1549	0.30	1823	0.49										
1500	955	1257	0.13	1399	0.20	1661	0.37	1907	0.57	2137	0.79	2341	1.03						
1800	1146	1461	0.19	1575	0.27	1807	0.46	2020	0.67	2228	0.91	2423	1.16	2607	1.43	2776	1.72		
2100	1337	1669	0.27	1763	0.36	1967	0.56	2162	0.80	2341	1.04	2523	1.31	2690	1.60	2858	1.90	3016	2.22
2400	1528	1881	0.38	1966	0.48	2139	0.69	2317	0.94	2484	1.21	2640	1.49	2801	1.79	2954	2.11	3099	2.44
2700	1719	2095	0.51	2172	0.62	2323	0.85	2479	1.11	2636	1.40	2785	1.71	2926	2.02	3067	2.35	3208	2.70
3000	1910	2310	0.68	2382	0.79	2514	1.04	2657	1.31	2799	1.62	2938	1.94	3072	2.28	3201	2.63	3322	2.98
3300	2101	2527	0.88	2593	1.00	2716	1.26	2840	1.55	2969	1.86	3100	2.21	3226	2.57	3348	2.94	3467	3.32
3600	2292	2745	1.11	2806	1.25	2922	1.53	3029	1.82	3150	2.16	3265	2.50	3387	2.88	3503	3.28	3615	3.68
3900	2484	2964	1.39	3021	1.54	3129	1.84	3231	2.15	3335	2.49	3446	2.86	3551	3.23	3665	3.65	3772	4.08
4200	2675	3184	1.71	3237	1.87	3338	2.19	3435	2.53	3527	2.87	3630	3.25	3731	3.65				
4500	2866	3404	2.08	3453	2.25	3549	2.59	3641	2.95	3729	3.31								

Inlet Sound Power, L _{Wi} [dB ref 10 ⁻¹² watts]										
RPM	% WOV	1	2	3	4	5	6	7	8	L _{Wi} A
1400	100	77	78	71	73	67	68	61	52	75
	80	77	78	69	68	65	64	60	52	72
	60	78	78	68	65	62	61	60	52	70
	50	78	77	68	64	62	60	60	52	69
2000	100	78	78	78	79	75	75	73	59	82
	80	74	77	76	75	71	72	66	58	78
	60	74	76	75	71	68	68	64	58	75
	50	76	77	75	70	67	67	63	58	74
2600	100	83	82	80	80	78	77	83	68	86
	80	80	82	81	78	75	76	74	65	82
	60	79	81	79	76	73	74	70	65	80
	50	81	81	79	75	72	73	69	65	79
3200	100	85	85	82	82	81	80	87	79	90
	80	82	85	83	81	79	78	79	70	86
	60	83	85	82	81	77	77	74	70	84
	50	83	84	82	81	77	77	74	70	84
3800	100	86	87	85	86	86	84	88	91	95
	80	80	87	83	83	82	80	80	74	88
	60	85	88	85	85	80	79	77	74	87
	50	84	87	84	86	81	80	78	74	88

Outlet Sound Power, L _{Wo} [dB ref 10 ⁻¹² watts]										
RPM	% WOV	1	2	3	4	5	6	7	8	L _{Wo} A
1400	100	87	83	75	74	72	71	63	59	78
	80	87	81	74	71	70	68	62	58	76
	60	88	82	74	70	68	67	62	59	75
	50	89	81	73	70	67	66	62	59	74
2000	100	84	84	80	80	80	77	75	64	84
	80	84	84	77	77	77	75	69	64	81
	60	85	84	76	75	74	71	67	64	79
	50	87	84	76	75	73	70	66	64	79
2600	100	90	93	83	82	83	80	82	72	89
	80	92	90	81	79	82	79	75	69	86
	60	90	89	81	79	79	77	73	69	84
	50	91	90	81	78	78	76	71	70	84
3200	100	93	95	88	85	86	83	86	81	92
	80	94	92	85	82	85	82	80	74	89
	60	93	92	85	82	83	81	77	74	88
	50	95	93	86	81	83	80	76	74	88
3800	100	93	94	93	90	90	88	87	92	97
	80	93	92	89	85	87	84	83	77	92
	60	96	93	89	85	87	84	81	77	91
	50	97	94	90	85	87	84	81	77	92

Performance certified is for installation type B: Free inlet, Ducted outlet. Power rating (Bhp) does not include transmission losses. Performance ratings do not include the effects of appurtenances (accessories).

The sound power level ratings shown are in decibels, referred to 10⁻¹² watts, calculated per AMCA Standard 301. Values shown are for inlet L_{Wi}, L_{Wi}A and outlet L_{Wo}, L_{Wo}A sound power levels for installation type B: Free inlet, Ducted outlet. Ratings for inlet sound do not include the effects of duct end correction. Ratings for outlet sound include the effects of duct end correction. The A-weighted sound power ratings shown have been calculated per AMCA Standard 301. The AMCA Certified Ratings Seal applies to L_{Wi}A and L_{Wo}A values only.

Performance Data		
Maximum Fan RPM	4000	
Specification Data		
Maximum Motor Frame Size	184T	
Minimum Motor Starting hp	1/3 hp	.25 kW
Wheel Diameter	15 in.	381 mm
Approximate Weight (Less Motor & Drives)	180 lbs.	82 kg.
Maximum Bhp = (Fan RPM / 2345) ³		
Outlet Velocity (FPM) = CFM / 1.56		
Tip Speed (FPM) = Fan RPM x 3.93		
% WOV = (CFM x 100) / (Fan RPM x 1.16)		

Imperial data — Metric data

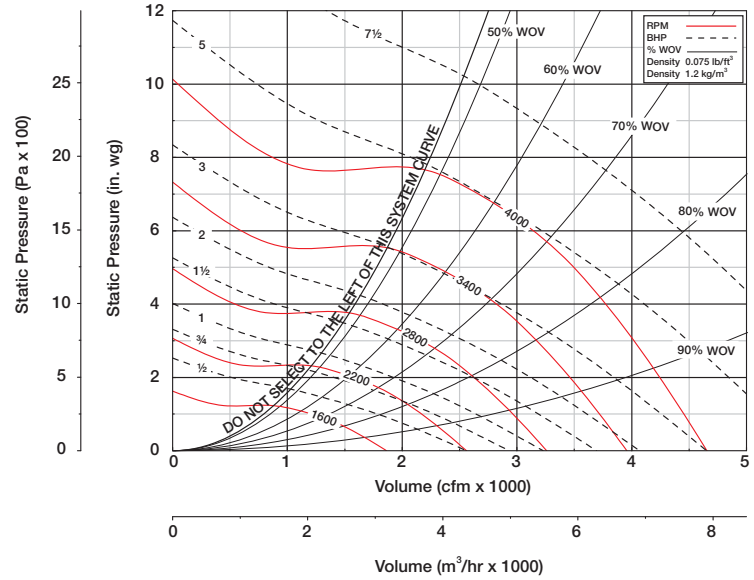

Performance Data

CFM	OV	STATIC PRESSURE (inches wg)																	
		0		0.5		1		2		3		4		5		6		7	
		RPM	BHP	RPM	BHP	RPM	BHP	RPM	BHP	RPM	BHP	RPM	BHP	RPM	BHP	RPM	BHP	RPM	BHP
1400	891	1203	0.08	1460	0.21	1696	0.37	2131	0.75	2510	1.21								
1600	1019	1375	0.12	1604	0.26	1812	0.43	2213	0.84	2574	1.31	2894	1.84						
1800	1146	1547	0.17	1752	0.33	1943	0.51	2301	0.93	2641	1.43	2957	1.98	3239	2.59				
2000	1273	1719	0.24	1906	0.41	2080	0.60	2410	1.05	2728	1.56	3021	2.13	3302	2.76	3557	3.43		
2200	1401	1891	0.32	2062	0.50	2223	0.71	2522	1.17	2817	1.71	3102	2.30	3366	2.95	3620	3.64	3854	4.37
2400	1528	2062	0.41	2221	0.61	2370	0.83	2653	1.32	2924	1.88	3190	2.49	3443	3.15	3684	3.86	3917	4.62
2600	1656	2234	0.52	2381	0.74	2519	0.97	2785	1.48	3035	2.06	3283	2.70	3530	3.38	3759	4.11	3981	4.88
2800	1783	2406	0.65	2543	0.88	2673	1.13	2921	1.66	3157	2.27	3393	2.92	3618	3.63	3846	4.38		
3000	1910	2578	0.80	2706	1.05	2829	1.31	3064	1.87	3289	2.49	3504	3.17	3722	3.90	3934	4.67		
3200	2038	2750	0.98	2871	1.24	2987	1.51	3209	2.10	3421	2.74	3624	3.44	3831	4.19				
3400	2165	2922	1.17	3036	1.45	3145	1.74	3356	2.35	3556	3.01	3755	3.74	3943	4.50				
3600	2292	3094	1.39	3202	1.68	3305	1.99	3504	2.62	3699	3.32	3887	4.06						

Shaded values show where Class I fan selections are more efficient than Class II.

		Inlet Sound Power, L _{Wi} [dB ref 10 ⁻¹² watts]									
RPM	% WOV	1	2	3	4	5	6	7	8	L _{Wi} A	
1600	100	72	77	77	74	70	69	69	56	77	
	80	74	79	75	69	66	67	61	55	73	
	60	73	80	75	66	64	64	58	55	72	
	50	74	80	76	65	63	63	57	54	72	
2200	100	76	77	78	78	76	75	76	67	82	
	80	76	78	76	74	72	72	68	63	78	
	60	76	79	75	71	70	70	66	62	76	
	50	77	79	75	71	69	68	64	62	76	
2800	100	83	82	83	80	80	78	78	79	86	
	80	86	86	81	77	76	75	73	68	82	
	60	85	91	79	76	75	75	72	67	82	
	50	86	89	80	76	74	74	70	67	81	
3400	100	83	86	85	83	83	82	80	85	90	
	80	87	86	83	80	80	79	76	72	85	
	60	87	90	82	79	79	78	76	71	85	
	50	87	89	83	80	78	78	75	71	85	
4000	100	80	89	86	86	87	86	84	89	93	
	80	82	83	83	81	83	82	79	76	88	
	60	84	82	85	81	82	81	79	75	87	
	50	84	83	85	83	82	81	79	75	88	

		Outlet Sound Power, L _{Wo} [dB ref 10 ⁻¹² watts]									
RPM	% WOV	1	2	3	4	5	6	7	8	L _{Wo} A	
1600	100	87	83	78	75	74	71	69	58	79	
	80	84	85	73	70	71	69	63	58	76	
	60	85	84	73	68	68	66	61	58	75	
	50	87	84	73	68	68	65	60	59	74	
2200	100	89	85	80	80	80	77	75	67	84	
	80	87	84	77	76	77	74	70	66	81	
	60	88	82	77	74	74	72	67	66	79	
	50	89	83	77	74	74	71	67	66	79	
2800	100	97	89	86	83	84	81	78	78	89	
	80	91	90	83	80	82	79	75	71	86	
	60	91	87	83	79	80	77	73	71	85	
	50	93	88	83	79	79	76	73	70	84	
3400	100	98	91	88	86	88	85	81	84	92	
	80	93	90	86	83	85	82	79	75	89	
	60	93	89	86	83	84	81	78	75	89	
	50	95	89	86	83	83	81	77	74	88	
4000	100	95	90	90	89	91	89	85	87	96	
	80	94	88	87	85	88	86	82	78	92	
	60	94	89	89	85	88	85	82	78	92	
	50	94	89	88	86	87	84	82	78	91	

Performance certified is for installation type B: Free inlet, Ducted outlet. Power rating (Bhp) does not include transmission losses. Performance ratings do not include the effects of appurtenances (accessories).

The sound power level ratings shown are in decibels, referred to 10⁻¹² watts, calculated per AMCA Standard 301. Values shown are for inlet L_{Wi}, L_{Wi}A and outlet L_{Wo}, L_{Wo}A sound power levels for installation type B: Free inlet, Ducted outlet. Ratings for inlet sound do not include the effects of duct end correction. Ratings for outlet sound include the effects of duct end correction. The A-weighted sound power ratings shown have been calculated per AMCA Standard 301. The AMCA Certified Ratings Seal applies to L_{Wi}A and L_{Wo}A values only.

Performance Data		
Maximum Fan RPM	2721	
Specification Data		
Maximum Motor Frame Size	213T	
Minimum Motor Starting hp	1/3 hp	.25 kW
Wheel Diameter	18.25 in.	464 mm
Approximate Weight (Less Motor & Drives)	190 lbs.	82 kg.
Maximum Bhp = (Fan RPM / 1617) ³		
Outlet Velocity (FPM) = CFM / 2.32		
Tip Speed (FPM) = Fan RPM x 4.78		
% WOV = (CFM x 100) / (Fan RPM x 2.55)		

Imperial data — Metric data

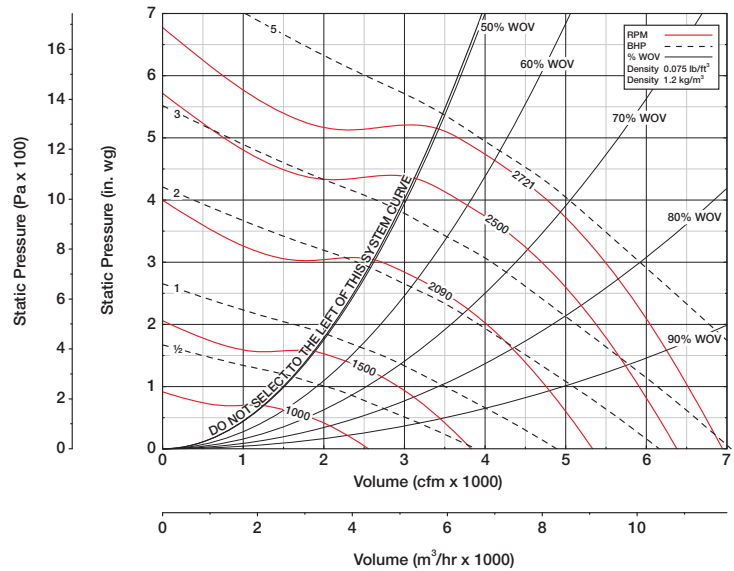

Performance Data

CFM	OV	STATIC PRESSURE (inches wg)																	
		0.25		0.5		1		1.5		2		2.5		3		3.5		4	
		RPM	BHP	RPM	BHP	RPM	BHP	RPM	BHP	RPM	BHP	RPM	BHP	RPM	BHP	RPM	BHP	RPM	BHP
1700	732	823	0.12	965	0.21	1229	0.44												
2100	905	952	0.17	1072	0.28	1301	0.52	1508	0.81										
2500	1077	1088	0.24	1194	0.36	1391	0.62	1580	0.93	1753	1.27	1915	1.64						
2900	1250	1231	0.33	1323	0.46	1495	0.75	1662	1.07	1827	1.43	1976	1.83	2122	2.24	2257	2.68		
3300	1422	1376	0.44	1456	0.59	1615	0.92	1763	1.25	1907	1.62	2054	2.03	2188	2.47	2317	2.94	2443	3.42
3700	1594	1524	0.58	1597	0.74	1740	1.11	1875	1.47	2008	1.86	2135	2.27	2266	2.73	2390	3.22	2505	3.72
4100	1767	1674	0.75	1740	0.93	1870	1.31	1996	1.73	2114	2.13	2236	2.56	2350	3.02	2469	3.52	2583	4.05
4500	1939	1825	0.95	1885	1.14	2003	1.55	2121	2.01	2234	2.45	2339	2.90	2451	3.38	2556	3.88	2663	4.41
4900	2112	1977	1.19	2031	1.40	2141	1.83	2251	2.31	2356	2.82	2458	3.29	2553	3.77	2657	4.30		
5300	2284	2130	1.47	2180	1.69	2282	2.16	2383	2.65	2483	3.20	2579	3.73	2672	4.24				
5700	2456	2283	1.79	2330	2.03	2426	2.52	2517	3.04	2613	3.61	2704	4.20						
6100	2629	2436	2.16	2481	2.41	2570	2.94	2657	3.48										

Inlet Sound Power, L _{Wi} [dB ref 10 ⁻¹² watts]										
RPM	% WOV	1	2	3	4	5	6	7	8	L _{Wi} A
650	100	63	61	59	56	57	52	48	35	60
	80	62	59	59	53	54	51	48	35	59
	60	60	59	57	52	54	51	47	35	58
	50	60	59	56	52	53	51	47	35	58
1000	100	65	66	68	65	60	63	52	44	68
	80	63	63	65	62	58	56	51	42	64
	60	63	63	63	60	57	55	50	42	63
	50	66	64	63	59	57	55	50	42	62
1400	100	69	77	73	72	69	67	69	53	75
	80	68	76	70	68	66	63	58	50	71
	60	67	70	68	66	65	62	57	50	69
	50	68	71	70	65	64	61	56	50	69
2000	100	73	73	82	81	78	74	77	65	84
	80	68	76	76	78	74	72	67	61	80
	60	75	77	77	76	72	70	67	62	78
	50	81	80	77	76	72	71	67	61	78
2721	100	79	78	86	88	86	83	80	83	91
	80	80	73	83	85	81	79	74	69	86
	60	78	75	78	81	79	77	73	69	84
	50	80	79	80	81	78	76	74	70	83

Outlet Sound Power, L _{Wo} [dB ref 10 ⁻¹² watts]										
RPM	% WOV	1	2	3	4	5	6	7	8	L _{Wo} A
650	100	74	65	60	58	59	54	52	39	63
	80	69	64	59	57	57	55	52	40	62
	60	70	64	58	56	57	54	52	40	61
	50	71	64	58	56	57	55	52	40	61
1000	100	73	73	66	68	65	64	55	47	70
	80	75	74	64	66	63	60	56	47	68
	60	76	73	64	65	62	59	55	47	68
	50	77	74	64	65	62	59	55	47	68
1400	100	79	79	74	74	73	69	70	56	78
	80	79	74	72	71	71	67	61	55	74
	60	77	75	73	69	68	66	61	55	73
	50	80	75	72	69	68	65	61	55	73
2000	100	83	82	81	83	82	78	78	68	86
	80	79	78	77	79	79	75	70	63	82
	60	83	81	78	77	77	74	69	64	81
	50	86	83	79	77	76	73	69	64	81
2721	100	91	85	87	90	90	86	82	84	94
	80	88	83	81	84	86	84	78	72	90
	60	87	87	83	82	83	81	77	71	88
	50	90	89	85	83	83	81	76	72	88

Performance certified is for installation type B: Free inlet, Ducted outlet. Power rating (Bhp) does not include transmission losses. Performance ratings do not include the effects of appurtenances (accessories).

The sound power level ratings shown are in decibels, referred to 10⁻¹² watts, calculated per AMCA Standard 301. Values shown are for inlet L_{Wi}, L_{Wi}A and outlet L_{Wo}, L_{Wo}A sound power levels for installation type B: Free inlet, Ducted outlet. Ratings for inlet sound do not include the effects of duct end correction. Ratings for outlet sound include the effects of duct end correction. The A-weighted sound power ratings shown have been calculated per AMCA Standard 301. The AMCA Certified Ratings Seal applies to L_{Wi}A and L_{Wo}A values only.

Performance Data		
Maximum Fan RPM	3445	
Specification Data		
Maximum Motor Frame Size	215T	
Minimum Motor Starting hp	1/3 hp	.25 kW
Wheel Diameter	18.25 in.	464 mm
Approximate Weight (Less Motor & Drives)	220 lbs.	100 kg.
Maximum Bhp = (Fan RPM / 1666) ³		
Outlet Velocity (FPM) = CFM / 2.32		
Tip Speed (FPM) = Fan RPM x 4.78		
% WOV = (CFM x 100) / (Fan RPM x 2.20)		

Imperial data — Metric data

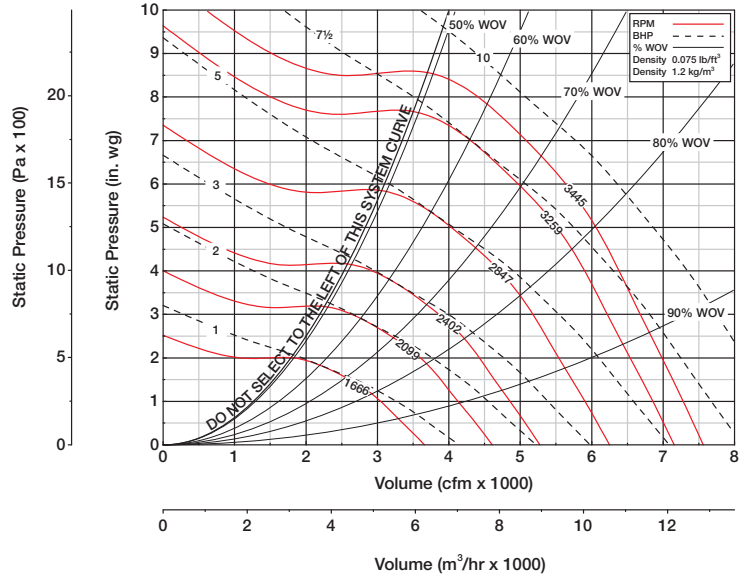

Performance Data

CFM	OV	STATIC PRESSURE (inches wg)																	
		0.5		1		2		3		4		5		6		7		8	
		RPM	BHP	RPM	BHP	RPM	BHP	RPM	BHP	RPM	BHP	RPM	BHP	RPM	BHP	RPM	BHP	RPM	BHP
2500	1077	1315	0.42	1471	0.64	1790	1.23	2082	1.91										
2800	1206	1436	0.53	1575	0.77	1864	1.38	2131	2.09	2392	2.88								
3100	1336	1559	0.65	1687	0.92	1948	1.54	2201	2.29	2435	3.11	2670	3.99	2884	4.93				
3400	1465	1684	0.79	1805	1.10	2034	1.72	2275	2.51	2500	3.36	2713	4.28	2926	5.25	3122	6.28		
3700	1594	1810	0.96	1926	1.30	2137	1.95	2358	2.75	2570	3.64	2771	4.59	2968	5.59	3164	6.66	3347	7.76
4000	1724	1938	1.15	2047	1.52	2242	2.21	2443	3.01	2647	3.94	2841	4.92	3023	5.96	3207	7.05	3389	8.20
4300	1853	2067	1.37	2170	1.76	2353	2.50	2538	3.31	2730	4.26	2913	5.29	3093	6.36	3261	7.48	3431	8.65
4600	1982	2197	1.61	2294	2.04	2471	2.84	2641	3.67	2816	4.61	2995	5.67	3164	6.78	3331	7.94		
4900	2112	2328	1.89	2420	2.34	2590	3.22	2746	4.05	2908	5.01	3080	6.09	3243	7.24	3402	8.43		
5200	2241	2460	2.20	2546	2.67	2710	3.64	2856	4.49	3011	5.47	3165	6.53	3326	7.72				
5500	2370	2592	2.55	2673	3.04	2831	4.07	2973	4.99	3115	5.96	3259	7.04	3411	8.23				
5800	2500	2724	2.93	2802	3.45	2953	4.53	3092	5.53	3221	6.50	3362	7.61						

Shaded values show where Class I fan selections are more efficient than Class II.

Inlet Sound Power, L _{Wi} [dB ref 10 ⁻¹² watts]										
RPM	% WOV	1	2	3	4	5	6	7	8	L _{Wi} A
1000	100	64	70	70	72	66	65	55	48	73
	80	62	66	67	66	63	60	52	43	68
	60	61	62	63	62	61	58	51	42	65
	50	62	63	63	62	60	58	51	41	65
1400	100	67	69	73	74	71	72	64	56	78
	80	66	65	71	72	68	67	61	53	75
	60	67	66	68	68	66	65	58	51	71
	50	69	67	69	67	65	63	57	52	71
2000	100	71	73	78	77	77	75	79	66	84
	80	67	69	76	75	74	73	70	62	79
	60	71	71	74	74	72	71	68	61	77
	50	75	74	76	74	72	71	67	61	77
2700	100	78	78	79	85	85	83	87	77	91
	80	79	74	76	85	84	80	77	71	88
	60	81	78	77	82	82	78	75	70	85
	50	81	80	79	82	81	78	74	70	85
3445	100	79	82	84	89	90	88	91	87	96
	80	75	79	81	85	87	85	83	78	91
	60	79	83	82	82	84	83	81	77	89
	50	81	85	85	86	85	82	80	77	90

Outlet Sound Power, L _{Wo} [dB ref 10 ⁻¹² watts]										
RPM	% WOV	1	2	3	4	5	6	7	8	L _{Wo} A
1000	100	76	75	69	72	70	67	55	47	74
	80	75	72	67	67	68	62	53	44	71
	60	75	72	67	64	66	60	53	44	69
	50	75	71	67	64	65	60	52	44	68
1400	100	80	76	74	76	76	73	66	56	80
	80	78	74	71	72	74	69	62	52	77
	60	79	75	71	70	72	67	60	52	75
	50	79	75	71	70	72	67	60	52	75
2000	100	90	81	81	83	82	78	79	66	87
	80	88	78	77	79	80	76	72	65	84
	60	87	82	78	77	78	74	69	63	82
	50	89	83	79	78	78	73	69	64	82
2700	100	87	85	85	88	90	86	86	78	94
	80	85	85	83	83	88	83	79	72	90
	60	88	89	87	82	86	81	77	71	89
	50	89	90	87	83	86	80	77	72	89
3445	100	91	90	91	93	95	93	92	89	100
	80	89	92	91	89	92	89	86	80	96
	60	92	94	93	87	90	87	84	79	94
	50	93	94	93	89	90	87	83	78	94

Performance certified is for installation type B: Free inlet, Ducted outlet. Power rating (Bhp) does not include transmission losses. Performance ratings do not include the effects of appurtenances (accessories).

The sound power level ratings shown are in decibels, referred to 10⁻¹² watts, calculated per AMCA Standard 301. Values shown are for inlet L_{Wi}, L_{Wi}A and outlet L_{Wo}, L_{Wo}A sound power levels for installation type B: Free inlet, Ducted outlet. Ratings for inlet sound do not include the effects of duct end correction. Ratings for outlet sound include the effects of duct end correction. The A-weighted sound power ratings shown have been calculated per AMCA Standard 301. The AMCA Certified Ratings Seal applies to L_{Wi}A and L_{Wo}A values only.

Performance Data			
Maximum Fan RPM	2483		
Specification Data			
Maximum Motor Frame Size	213T		
Minimum Motor Starting hp	1/3 hp	.25 kW	
Wheel Diameter	20 in.	508 mm	
Approximate Weight (Less Motor & Drives)	220 lbs.	100 kg.	
Maximum Bhp = (Fan RPM / 1387) ³			
Outlet Velocity (FPM) = CFM / 2.79			
Tip Speed (FPM) = Fan RPM x 5.24			
% WOV = (CFM x 100) / (Fan RPM x 3.36)			

Imperial data — *Metric data*

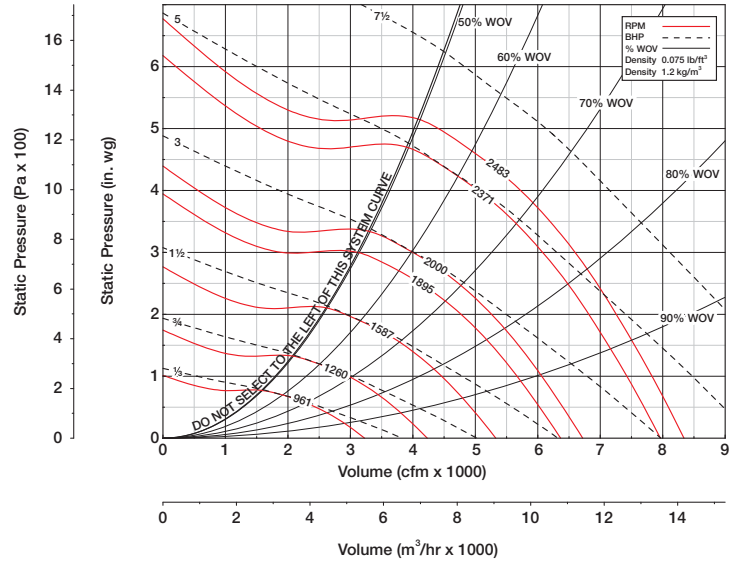

Performance Data

CFM	OV	STATIC PRESSURE (inches wg)																	
		0.25		0.5		1		1.5		2		2.5		3		3.5		4	
		RPM	BHP	RPM	BHP	RPM	BHP	RPM	BHP	RPM	BHP	RPM	BHP	RPM	BHP	RPM	BHP	RPM	BHP
2400	860	837	0.19	951	0.31	1169	0.59	1362	0.94										
2800	1003	939	0.25	1039	0.39	1230	0.69	1411	1.05	1576	1.45								
3200	1146	1046	0.33	1134	0.48	1307	0.81	1471	1.18	1625	1.60	1770	2.06	1904	2.54				
3600	1290	1155	0.43	1235	0.59	1389	0.95	1538	1.33	1684	1.77	1820	2.25	1950	2.76	2073	3.29	2188	3.85
4000	1433	1266	0.55	1338	0.72	1479	1.11	1616	1.52	1747	1.96	1879	2.46	2002	2.99	2119	3.55	2233	4.13
4400	1577	1378	0.69	1445	0.88	1573	1.29	1700	1.73	1824	2.20	1940	2.69	2062	3.25	2174	3.83	2280	4.43
4800	1720	1492	0.85	1554	1.06	1673	1.50	1789	1.97	1901	2.46	2016	2.98	2121	3.52	2234	4.13	2338	4.76
5200	1863	1607	1.05	1664	1.27	1774	1.74	1880	2.24	1989	2.76	2093	3.30	2198	3.87	2294	4.46	2399	5.11
5600	2007	1722	1.27	1774	1.51	1878	2.01	1979	2.54	2078	3.09	2177	3.65	2274	4.25	2371	4.86	2461	5.49
6000	2150	1837	1.52	1886	1.77	1984	2.31	2080	2.87	2170	3.45	2265	4.04	2355	4.66	2447	5.29		
6400	2293	1954	1.81	1999	2.08	2092	2.64	2181	3.23	2269	3.84	2355	4.47	2443	5.11				
6800	2437	2070	2.14	2113	2.42	2201	3.01	2284	3.63	2369	4.27	2449	4.93						

Inlet Sound Power, L _{Wi} [dB ref 10 ⁻¹² watts]										
RPM	% WOV	1	2	3	4	5	6	7	8	L _{Wi} A
600	100	65	62	60	57	57	52	47	34	61
	80	64	61	59	55	55	52	47	35	59
	60	62	60	57	53	54	52	47	35	59
	50	62	60	57	53	54	52	47	35	58
900	100	65	67	68	65	61	62	51	43	68
	80	64	64	65	62	58	56	50	41	64
	60	63	63	63	60	57	55	49	41	63
	50	66	65	63	60	57	55	49	41	62
1250	100	71	78	73	72	69	67	67	51	75
	80	69	78	70	68	65	62	57	49	71
	60	68	71	68	66	65	61	57	50	69
	50	69	73	69	65	64	60	55	50	69
1750	100	73	75	81	80	77	75	75	62	83
	80	69	76	76	77	73	71	66	59	79
	60	75	77	77	75	71	70	66	60	77
	50	80	80	77	75	71	70	66	60	77
2483	100	80	80	88	88	86	83	81	84	92
	80	80	75	84	85	81	79	74	69	87
	60	78	77	80	82	79	77	74	70	84
	50	81	80	82	81	78	77	74	70	84

Outlet Sound Power, L _{Wo} [dB ref 10 ⁻¹² watts]										
RPM	% WOV	1	2	3	4	5	6	7	8	L _{Wo} A
600	100	75	66	60	59	60	55	51	39	64
	80	70	65	60	58	58	55	51	39	62
	60	71	64	59	57	58	55	51	40	62
	50	72	64	59	57	57	55	51	40	62
900	100	74	73	67	68	65	63	55	46	70
	80	76	73	65	66	63	60	55	46	68
	60	76	72	64	65	62	59	54	46	67
	50	77	73	65	65	62	59	54	46	67
1250	100	80	80	74	74	72	70	68	54	77
	80	78	75	72	71	70	66	61	54	74
	60	77	75	72	69	68	65	60	55	73
	50	79	76	72	69	68	65	60	55	73
1750	100	82	82	81	83	81	78	76	65	86
	80	79	78	77	79	78	74	69	62	82
	60	83	80	77	77	76	73	68	62	80
	50	86	82	79	77	75	72	68	63	80
2483	100	91	86	88	90	90	87	83	85	94
	80	88	84	82	85	87	84	78	72	90
	60	88	88	85	83	84	81	77	72	88
	50	90	89	86	84	84	81	77	72	88

Performance certified is for installation type B: Free inlet, Ducted outlet. Power rating (Bhp) does not include transmission losses. Performance ratings do not include the effects of appurtenances (accessories).

The sound power level ratings shown are in decibels, referred to 10⁻¹² watts, calculated per AMCA Standard 301. Values shown are for inlet L_{Wi}, L_{Wi}A and outlet L_{Wo}, L_{Wo}A sound power levels for installation type B: Free inlet, Ducted outlet. Ratings for inlet sound do not include the effects of duct end correction. Ratings for outlet sound include the effects of duct end correction. The A-weighted sound power ratings shown have been calculated per AMCA Standard 301. The AMCA Certified Ratings Seal applies to L_{Wi}A and L_{Wo}A values only.

Performance Data		
Maximum Fan RPM	3145	
Specification Data		
Maximum Motor Frame Size	215T	
Minimum Motor Starting hp	1/3 hp	.25 kW
Wheel Diameter	20 in.	508 mm
Approximate Weight (Less Motor & Drives)	240 lbs.	109 kg.
Maximum Bhp = (Fan RPM / 1430) ³		
Outlet Velocity (FPM) = CFM / 2.79		
Tip Speed (FPM) = Fan RPM x 5.24		
% WOV = (CFM x 100) / (Fan RPM x 2.89)		

Imperial data — Metric data

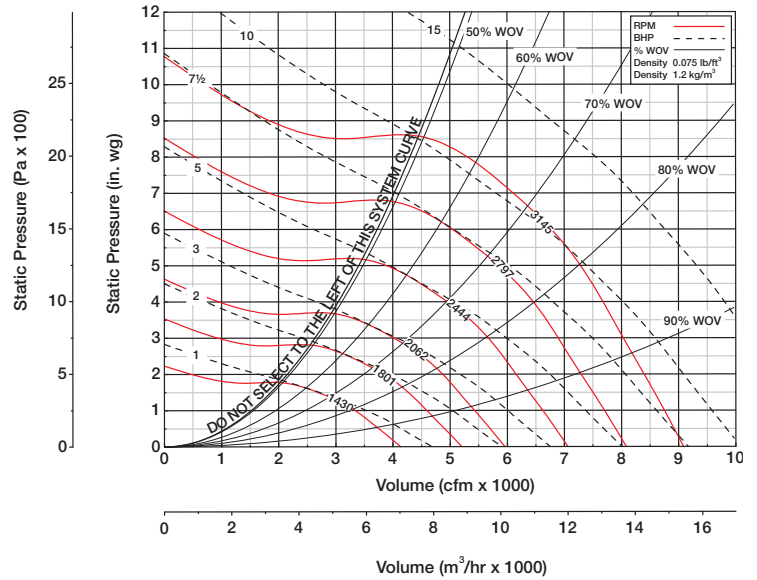

Performance Data

CFM	OV	STATIC PRESSURE (inches wg)																	
		0.5		1		2		3		4		5		6		7		8	
		RPM	BHP	RPM	BHP	RPM	BHP	RPM	BHP	RPM	BHP	RPM	BHP	RPM	BHP	RPM	BHP	RPM	BHP
3000	1075	1199	0.50	1342	0.77	1633	1.48	1900	2.29										
3300	1182	1291	0.61	1421	0.89	1688	1.62	1934	2.47	2176	3.41								
3600	1290	1384	0.73	1503	1.03	1750	1.78	1987	2.66	2209	3.63	2424	4.68						
3900	1397	1478	0.86	1592	1.20	1816	1.95	2041	2.88	2249	3.88	2456	4.96	2650	6.11				
4200	1505	1574	1.01	1683	1.39	1887	2.16	2100	3.10	2302	4.14	2488	5.25	2682	6.44	2861	7.68		
4500	1612	1670	1.18	1774	1.61	1965	2.39	2163	3.35	2356	4.42	2539	5.57	2715	6.78	2893	8.07	3060	9.40
4800	1720	1767	1.38	1867	1.83	2045	2.65	2229	3.61	2415	4.73	2592	5.91	2758	7.15	2926	8.46	3092	9.84
5100	1827	1865	1.59	1960	2.06	2128	2.94	2299	3.91	2478	5.05	2646	6.27	2811	7.55	2964	8.88	3124	10.3
5400	1935	1964	1.83	2054	2.33	2217	3.27	2377	4.26	2543	5.39	2707	6.65	2865	7.97	3017	9.34		
5700	2043	2063	2.10	2149	2.62	2307	3.63	2457	4.63	2608	5.76	2770	7.05	2920	8.41	3071	9.82		
6000	2150	2163	2.39	2245	2.93	2398	4.02	2537	5.03	2684	6.19	2835	7.48	2983	8.87	3125	10.3		
6300	2258	2263	2.71	2341	3.27	2489	4.45	2623	5.48	2762	6.66	2900	7.93	3046	9.36				

Shaded values show where Class I fan selections are more efficient than Class II.

Inlet Sound Power, L _{Wi} [dB ref 10 ⁻¹² watts]										
RPM	% WOV	1	2	3	4	5	6	7	8	L _{WiA}
900	100	66	71	71	72	66	64	54	47	72
	80	63	67	67	66	63	59	51	42	68
	60	62	63	63	63	61	57	50	41	65
	50	63	64	63	62	60	57	50	40	65
1250	100	68	70	73	74	71	71	63	55	77
	80	66	67	71	72	69	67	60	52	74
	60	67	66	68	68	66	64	57	51	71
	50	69	68	69	67	65	63	57	51	70
1750	100	71	74	78	77	77	76	77	63	83
	80	67	70	77	74	73	72	68	61	79
	60	71	72	74	73	72	70	66	60	77
	50	74	74	76	74	71	70	65	60	77
2475	100	79	79	81	86	86	84	86	77	92
	80	80	75	78	86	84	80	77	71	88
	60	82	79	78	83	82	78	75	70	86
	50	82	81	80	83	82	78	74	70	86
3145	100	81	84	85	91	91	89	92	87	97
	80	77	80	81	86	88	85	83	78	92
	60	81	84	83	83	85	83	81	77	90
	50	83	86	86	87	85	83	80	77	90

Outlet Sound Power, L _{Wo} [dB ref 10 ⁻¹² watts]										
RPM	% WOV	1	2	3	4	5	6	7	8	L _{WoA}
900	100	77	76	70	72	70	66	55	47	74
	80	75	73	67	67	67	61	52	43	71
	60	75	73	67	65	65	60	52	43	69
	50	75	72	67	64	65	59	52	43	68
1250	100	80	76	75	77	76	72	64	54	79
	80	78	74	71	73	73	68	60	51	76
	60	79	74	71	71	72	66	59	51	75
	50	78	75	71	70	71	66	59	51	75
1750	100	88	81	82	83	81	78	76	63	86
	80	86	78	77	79	79	75	70	63	83
	60	86	81	78	77	77	73	68	62	81
	50	88	82	79	78	77	72	68	62	81
2475	100	88	86	86	89	91	87	86	78	95
	80	86	86	84	84	88	83	79	72	91
	60	89	90	87	83	86	81	77	71	90
	50	90	91	87	84	86	81	77	72	89
3145	100	92	91	92	94	96	93	93	90	100
	80	90	93	91	90	93	90	86	80	97
	60	93	95	93	88	91	88	84	79	95
	50	94	95	94	90	91	87	83	79	95

Performance certified is for installation type B: Free inlet, Ducted outlet. Power rating (Bhp) does not include transmission losses. Performance ratings do not include the effects of appurtenances (accessories).

The sound power level ratings shown are in decibels, referred to 10⁻¹² watts, calculated per AMCA Standard 301. Values shown are for inlet L_{Wi}, L_{WiA} and outlet L_{Wo}, L_{WoA} sound power levels for installation type B: Free inlet, Ducted outlet. Ratings for inlet sound do not include the effects of duct end correction. Ratings for outlet sound include the effects of duct end correction. The A-weighted sound power ratings shown have been calculated per AMCA Standard 301. The AMCA Certified Ratings Seal applies to L_{WiA} and L_{WoA} values only.

Performance Data		
Maximum Fan RPM	2232	
Specification Data		
Maximum Motor Frame Size	215T	
Minimum Motor Starting hp	1/3 hp	.25 kW
Wheel Diameter	22.5 in.	565 mm
Approximate Weight (Less Motor & Drives)	260 lbs.	118 kg.
Maximum Bhp = (Fan RPM / 1199) ³		
Outlet Velocity (FPM) = CFM / 3.45		
Tip Speed (FPM) = Fan RPM x 5.83		
% WOV = (CFM x 100) / (Fan RPM x 4.50)		

Imperial data — Metric data

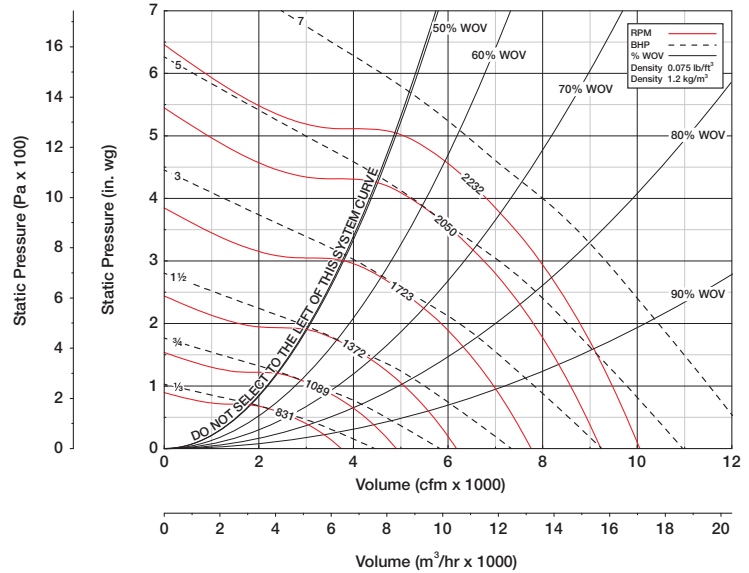

Performance Data

CFM	OV	STATIC PRESSURE (inches wg)																	
		0.25		0.5		1		1.5		2		2.5		3		3.5		4	
		RPM	BHP	RPM	BHP	RPM	BHP	RPM	BHP	RPM	BHP	RPM	BHP	RPM	BHP	RPM	BHP	RPM	BHP
2600	753	697	0.17	814	0.30	1026	0.62												
3100	898	788	0.23	889	0.37	1080	0.72	1250	1.12	1407	1.57								
3600	1043	886	0.31	972	0.46	1142	0.84	1300	1.26	1445	1.73	1583	2.24						
4100	1188	986	0.42	1062	0.58	1213	0.97	1358	1.43	1494	1.92	1622	2.45	1746	3.03	1861	3.63		
4600	1333	1088	0.54	1156	0.72	1293	1.13	1425	1.61	1552	2.14	1672	2.70	1785	3.28	1899	3.91	2006	4.57
5100	1478	1192	0.69	1254	0.89	1376	1.32	1498	1.81	1616	2.37	1730	2.96	1839	3.58	1940	4.22	2044	4.91
5600	1623	1298	0.87	1355	1.09	1466	1.55	1578	2.06	1686	2.62	1793	3.25	1897	3.91	1997	4.58	2090	5.28
6100	1768	1405	1.08	1456	1.32	1558	1.81	1660	2.33	1763	2.92	1862	3.56	1959	4.25	2055	4.96	2148	5.69
6600	1913	1513	1.33	1558	1.58	1653	2.11	1748	2.66	1843	3.26	1936	3.91	2029	4.62	2118	5.37	2206	6.14
7100	2057	1620	1.62	1662	1.88	1752	2.44	1840	3.02	1926	3.63	2016	4.31	2100	5.02	2187	5.79		
7600	2202	1729	1.94	1768	2.23	1851	2.82	1932	3.43	2015	4.07	2097	4.75	2180	5.49				
8100	2347	1837	2.31	1875	2.61	1952	3.24	2028	3.88	2106	4.56	2182	5.25						

Inlet Sound Power, L _{Wi} [dB ref 10 ⁻¹² watts]										
RPM	% WOV	1	2	3	4	5	6	7	8	L _{Wi} A
550	100	65	68	68	64	57	52	49	41	65
	80	61	67	68	64	56	52	48	40	65
	60	60	67	68	64	56	52	48	39	65
	50	62	67	67	64	56	51	48	39	64
800	100	66	70	69	64	59	61	49	41	67
	80	62	66	68	62	58	56	49	40	65
	60	61	64	66	60	55	55	49	40	63
	50	64	64	66	59	55	54	48	40	63
1100	100	70	78	73	72	67	68	66	53	75
	80	64	78	73	69	64	62	57	51	71
	60	66	73	70	67	62	61	57	52	69
	50	69	73	70	66	61	61	56	52	69
1600	100	77	80	87	82	78	75	77	64	85
	80	76	75	80	78	74	72	67	61	80
	60	78	77	83	75	71	70	66	62	79
	50	79	78	82	76	70	69	66	62	78
2232	100	80	83	92	89	87	84	81	83	92
	80	74	78	87	85	85	81	76	71	89
	60	80	79	82	82	82	78	74	70	86
	50	83	82	83	82	81	77	74	71	85

Outlet Sound Power, L _{Wo} [dB ref 10 ⁻¹² watts]										
RPM	% WOV	1	2	3	4	5	6	7	8	L _{Wo} A
550	100	74	74	67	66	63	55	53	45	68
	80	72	73	68	68	62	56	56	50	68
	60	69	72	67	67	62	56	56	51	68
	50	69	72	67	67	62	56	57	52	68
800	100	74	75	68	67	64	62	54	43	70
	80	71	73	66	65	63	58	54	43	68
	60	72	70	66	63	62	57	54	43	66
	50	72	70	65	63	61	57	54	43	66
1100	100	77	84	75	74	72	68	65	51	77
	80	73	80	70	71	69	64	59	50	74
	60	75	77	69	69	67	63	58	50	72
	50	77	77	70	69	66	62	58	51	71
1600	100	82	83	84	84	83	77	75	64	87
	80	78	83	80	80	80	75	70	64	83
	60	82	82	77	78	77	74	69	64	81
	50	86	84	78	78	76	73	69	64	81
2232	100	88	87	91	93	92	87	82	82	95
	80	83	83	85	89	90	85	79	72	93
	60	88	89	83	87	88	82	77	71	91
	50	93	92	85	86	87	81	76	72	90

Performance certified is for installation type B: Free inlet, Ducted outlet. Power rating (Bhp) does not include transmission losses. Performance ratings do not include the effects of appurtenances (accessories).

The sound power level ratings shown are in decibels, referred to 10⁻¹² watts, calculated per AMCA Standard 301. Values shown are for inlet L_{Wi}, L_{Wi}A and outlet L_{Wo}, L_{Wo}A sound power levels for installation type B: Free inlet, Ducted outlet. Ratings for inlet sound do not include the effects of duct end correction. Ratings for outlet sound include the effects of duct end correction. The A-weighted sound power ratings shown have been calculated per AMCA Standard 301. The AMCA Certified Ratings Seal applies to L_{Wi}A and L_{Wo}A values only.

Performance Data		
Maximum Fan RPM	2777	
Specification Data		
Maximum Motor Frame Size	254T	
Minimum Motor Starting hp	1/3 hp	.25 kW
Wheel Diameter	22.25 in.	565 mm
Approximate Weight (Less Motor & Drives)	310 lbs.	141 kg.
Maximum Bhp = (Fan RPM / 1219) ³		
Outlet Velocity (FPM) = CFM / 3.45		
Tip Speed (FPM) = Fan RPM x 5.83		
% WOV = (CFM x 100) / (Fan RPM x 3.80)		

Imperial data — Metric data

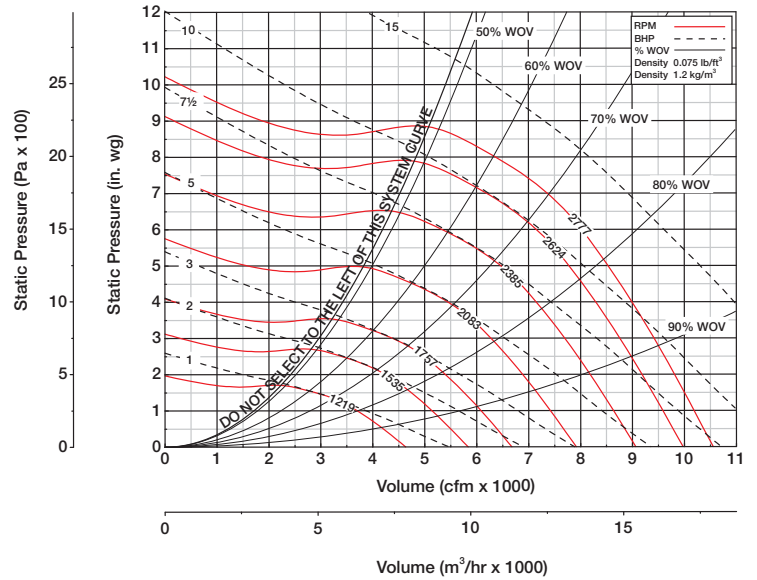

Performance Data

CFM	OV	STATIC PRESSURE (inches wg)																		
		0.5		1		2		3		4		5		6		7		8		
		RPM	BHP	RPM	BHP	RPM	BHP	RPM	BHP	RPM	BHP	RPM	BHP	RPM	BHP	RPM	BHP	RPM	BHP	
3800	1101	1124	0.64	1239	0.97	1467	1.74	1690	2.65	1900	3.67									
4200	1217	1219	0.79	1326	1.14	1538	1.98	1738	2.88	1934	3.94	2120	5.09	2290	6.31					
4600	1333	1315	0.96	1414	1.34	1609	2.25	1787	3.15	1977	4.24	2154	5.42	2323	6.69	2478	8.02			
5000	1449	1413	1.16	1503	1.56	1682	2.50	1858	3.50	2024	4.56	2193	5.78	2356	7.09	2511	8.47	2656	9.91	
5400	1565	1511	1.40	1595	1.82	1758	2.77	1929	3.89	2079	4.94	2241	6.18	2394	7.51	2545	8.93	2689	10.4	
5800	1681	1611	1.66	1690	2.11	1844	3.11	2001	4.29	2150	5.42	2289	6.60	2441	7.98	2582	9.42	2723	10.9	
6200	1797	1711	1.96	1786	2.44	1932	3.48	2075	4.66	2221	5.94	2354	7.14	2489	8.48	2629	9.97	2760	11.5	
6600	1913	1812	2.29	1883	2.81	2020	3.89	2150	5.07	2293	6.50	2424	7.76	2544	9.06	2676	10.5			
7000	2028	1913	2.66	1981	3.21	2110	4.34	2236	5.57	2366	6.98	2495	8.42	2615	9.77	2726	11.2			
7400	2144	2015	3.07	2079	3.66	2200	4.83	2323	6.12	2440	7.49	2568	9.11	2686	10.5					
7800	2260	2117	3.53	2178	4.16	2295	5.38	2411	6.70	2521	8.10	2641	9.71	2757	11.3					
8200	2376	2219	4.03	2277	4.70	2390	5.98	2500	7.34	2608	8.78	2715	10.4							

Shaded values show where Class I fan selections are more efficient than Class II.

Inlet Sound Power, L _{Wi} [dB ref 10 ⁻¹² watts]										
RPM	% WOV	1	2	3	4	5	6	7	8	L _{Wi} A
800	100	66	75	67	66	63	65	51	43	70
	80	63	71	64	63	62	62	51	41	67
	60	62	69	63	61	62	63	53	42	67
	50	77	73	69	65	62	62	50	41	68
1100	100	70	78	72	72	68	72	60	51	76
	80	62	73	68	67	66	66	57	48	71
	60	63	72	66	66	65	66	57	49	71
	50	66	72	67	65	64	65	56	49	70
1600	100	78	79	82	80	78	76	80	64	85
	80	71	76	77	75	74	73	67	60	79
	60	73	76	74	73	72	72	67	61	77
	50	77	77	76	73	72	71	66	61	77
2200	100	81	84	89	88	87	84	87	78	93
	80	75	78	83	83	82	80	76	69	87
	60	79	81	84	81	79	78	75	71	85
	50	83	83	84	81	78	77	74	70	85
2777	100	85	88	89	93	93	90	91	87	98
	80	80	83	85	89	90	87	82	76	93
	60	84	86	85	88	87	85	80	76	91
	50	87	89	89	88	86	84	80	76	91

Outlet Sound Power, L _{Wo} [dB ref 10 ⁻¹² watts]										
RPM	% WOV	1	2	3	4	5	6	7	8	L _{Wo} A
800	100	73	79	66	69	68	66	54	45	72
	80	70	76	63	67	66	63	53	46	70
	60	70	74	63	65	66	63	53	46	70
	50	70	75	63	65	65	62	53	47	69
1100	100	78	83	74	76	74	72	63	53	79
	80	73	77	69	73	72	68	60	50	76
	60	75	75	68	71	71	68	60	52	74
	50	77	77	70	71	70	68	60	53	75
1600	100	87	86	83	85	84	78	79	64	88
	80	84	80	77	81	80	75	70	61	84
	60	85	80	77	79	78	74	70	62	82
	50	86	82	78	79	77	74	69	62	82
2200	100	89	89	91	92	91	86	86	80	96
	80	85	86	85	88	89	83	79	73	92
	60	89	88	86	86	87	82	78	73	90
	50	91	89	88	87	86	81	77	73	90
2777	100	93	94	93	96	97	93	91	88	101
	80	88	91	89	92	94	90	86	79	97
	60	94	94	92	89	92	88	84	79	95
	50	96	95	92	91	92	88	84	79	96

Performance certified is for installation type B: Free inlet, Ducted outlet. Power rating (Bhp) does not include transmission losses. Performance ratings do not include the effects of appurtenances (accessories).

The sound power level ratings shown are in decibels, referred to 10⁻¹² watts, calculated per AMCA Standard 301. Values shown are for inlet L_{Wi}, L_{Wi}A and outlet L_{Wo}, L_{Wo}A sound power levels for installation type B: Free inlet, Ducted outlet. Ratings for inlet sound do not include the effects of duct end correction. Ratings for outlet sound include the effects of duct end correction. The A-weighted sound power ratings shown have been calculated per AMCA Standard 301. The AMCA Certified Ratings Seal applies to L_{Wi}A and L_{Wo}A values only.

Performance Data		
Maximum Fan RPM	2027	
Specification Data		
Maximum Motor Frame Size	215T	
Minimum Motor Starting hp	1/3 hp	.25 kW
Wheel Diameter	24.5 in.	622 mm
Approximate Weight (Less Motor & Drives)	310 lbs.	141 kg.
Maximum Bhp = (Fan RPM / 1021) ³		
Outlet Velocity (FPM) = CFM / 4.14		
Tip Speed (FPM) = Fan RPM x 6.41		
% WOV = (CFM x 100) / (Fan RPM x 6.01)		

Imperial data — Metric data

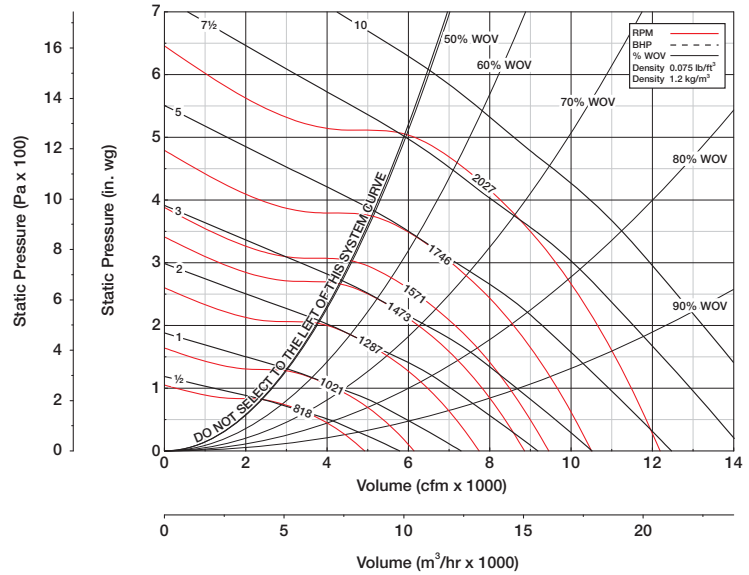

Performance Data

CFM	OV	STATIC PRESSURE (inches wg)																	
		0.25		0.5		1		1.5		2		2.5		3		3.5		4	
		RPM	BHP	RPM	BHP	RPM	BHP	RPM	BHP	RPM	BHP	RPM	BHP	RPM	BHP	RPM	BHP	RPM	BHP
3000	724	613	0.19	724	0.35	923	0.73												
3700	893	708	0.27	801	0.44	975	0.86	1132	1.34										
4400	1062	810	0.39	887	0.57	1040	1.02	1183	1.54	1314	2.11	1440	2.73						
5100	1231	915	0.53	982	0.74	1116	1.21	1245	1.78	1368	2.38	1480	3.03	1593	3.73	1697	4.47		
5800	1400	1023	0.72	1082	0.95	1201	1.45	1317	2.03	1428	2.70	1538	3.38	1637	4.11	1738	4.88	1835	5.69
6500	1570	1133	0.95	1187	1.20	1292	1.74	1398	2.34	1501	3.03	1599	3.78	1697	4.54	1789	5.34	1875	6.17
7200	1739	1245	1.23	1292	1.50	1388	2.09	1483	2.71	1577	3.41	1671	4.19	1759	5.02	1849	5.86	1934	6.74
7900	1908	1357	1.56	1400	1.86	1486	2.49	1574	3.15	1662	3.88	1746	4.66	1832	5.52	1913	6.42	1994	7.35
8600	2077	1470	1.96	1508	2.28	1590	2.95	1669	3.66	1748	4.40	1830	5.22	1907	6.07	1985	7.02		
9300	2246	1584	2.41	1619	2.76	1694	3.48	1766	4.23	1842	5.01	1915	5.84	1990	6.74				
10000	2415	1698	2.94	1731	3.32	1800	4.08	1868	4.88	1937	5.71	2005	6.56						
10700	2584	1812	3.55	1843	3.95	1907	4.76	1972	5.60										

Inlet Sound Power, L _{Wi} [dB ref 10 ⁻¹² watts]										
RPM	% WOV	1	2	3	4	5	6	7	8	L _{WiA}
500	100	66	69	68	64	57	53	49	40	65
	80	63	69	68	64	56	52	48	40	65
	60	62	69	68	64	56	52	48	39	65
	50	64	68	68	64	56	52	48	39	65
700	100	66	70	68	63	60	59	48	40	66
	80	62	67	67	62	57	55	48	38	64
	60	61	65	65	59	55	54	47	39	62
	50	63	65	65	59	55	53	47	38	62
1000	100	72	79	74	72	68	69	65	52	75
	80	67	79	73	69	65	62	57	51	72
	60	68	74	70	67	63	61	57	52	70
	50	71	74	70	66	62	61	57	52	69
1450	100	79	82	87	82	78	76	76	63	85
	80	77	77	81	78	75	72	67	61	80
	60	79	79	82	76	71	70	66	63	79
	50	80	80	82	76	71	69	66	63	79
2027	100	82	85	93	90	88	84	82	84	93
	80	76	80	88	86	85	81	76	71	89
	60	81	81	83	83	82	78	74	71	86
	50	84	83	84	83	81	77	74	71	86

Outlet Sound Power, L _{Wo} [dB ref 10 ⁻¹² watts]										
RPM	% WOV	1	2	3	4	5	6	7	8	L _{WoA}
500	100	75	74	68	67	62	56	53	45	68
	80	73	73	68	68	62	56	56	50	69
	60	71	72	68	68	62	57	56	51	68
	50	70	72	68	67	62	57	57	52	68
700	100	74	74	68	66	64	60	52	41	69
	80	72	72	66	64	62	58	52	41	67
	60	71	69	65	63	61	57	52	41	66
	50	71	69	65	62	61	56	52	41	65
1000	100	79	84	75	75	72	68	64	50	77
	80	75	80	71	72	70	64	58	50	74
	60	76	77	70	70	67	63	58	50	72
	50	78	77	70	69	67	63	58	51	72
1450	100	83	84	85	85	83	77	74	63	87
	80	79	82	81	81	80	75	69	63	84
	60	83	81	78	79	78	74	69	64	82
	50	86	83	79	79	76	73	69	64	81
2027	100	89	89	92	93	92	87	83	83	96
	80	84	84	86	90	90	85	79	72	93
	60	89	89	85	88	88	82	77	72	91
	50	93	92	86	87	87	81	76	72	90

Performance certified is for installation type B: Free inlet, Ducted outlet. Power rating (Bhp) does not include transmission losses. Performance ratings do not include the effects of appurtenances (accessories).

The sound power level ratings shown are in decibels, referred to 10⁻¹² watts, calculated per AMCA Standard 301. Values shown are for inlet L_{Wi}, L_{WiA} and outlet L_{Wo}, L_{WoA} sound power levels for installation type B: Free inlet, Ducted outlet. Ratings for inlet sound do not include the effects of duct end correction. Ratings for outlet sound include the effects of duct end correction. The A-weighted sound power ratings shown have been calculated per AMCA Standard 301. The AMCA Certified Ratings Seal applies to L_{WiA} and L_{WoA} values only.

Performance Data		
Maximum Fan RPM	2517	
Specification Data		
Maximum Motor Frame Size	254T	
Minimum Motor Starting hp	1/3 hp	.25 kW
Wheel Diameter	24.5 in.	622 mm
Approximate Weight (Less Motor & Drives)	360 lbs.	163 kg.
Maximum Bhp = (Fan RPM / 1038) ³		
Outlet Velocity (FPM) = CFM / 4.14		
Tip Speed (FPM) = Fan RPM x 6.41		
% WOV = (CFM x 100) / (Fan RPM x 5.07)		

Imperial data — Metric data

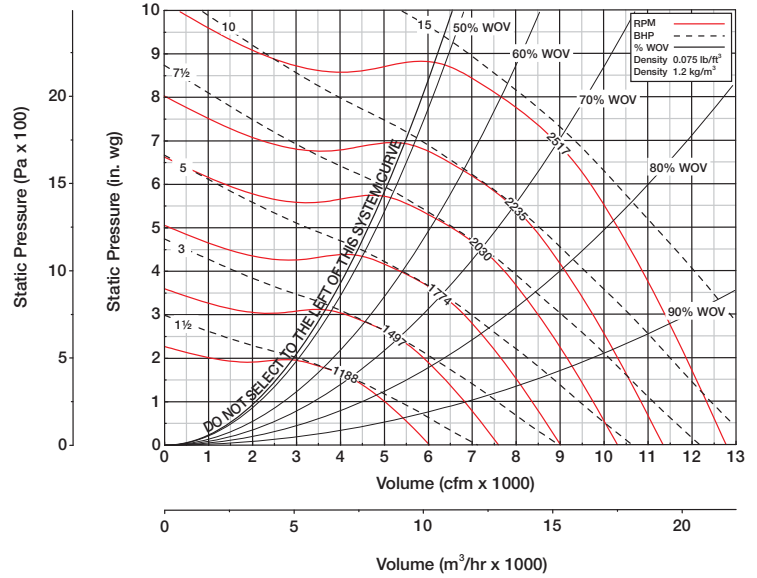

Performance Data

CFM	OV	STATIC PRESSURE (inches wg)																		
		0.5		1		2		3		4		5		6		7		8		
		RPM	BHP	RPM	BHP	RPM	BHP	RPM	BHP	RPM	BHP	RPM	BHP	RPM	BHP	RPM	BHP	RPM	BHP	
4500	1076	1002	0.74	1110	1.14	1319	2.05	1526	3.15	1719	4.38									
5000	1196	1090	0.92	1189	1.34	1384	2.34	1570	3.44	1750	4.71	1920	6.10							
5500	1315	1181	1.13	1271	1.58	1451	2.67	1615	3.75	1788	5.08	1951	6.51	2105	8.04	2246	9.65			
6000	1435	1272	1.38	1355	1.86	1519	2.99	1679	4.19	1833	5.48	1986	6.95	2136	8.53	2277	10.2	2408	11.9	
6500	1555	1364	1.66	1440	2.18	1589	3.32	1745	4.67	1882	5.94	2031	7.44	2170	9.05	2308	10.8	2439	12.6	
7000	1674	1457	1.99	1529	2.54	1670	3.74	1813	5.18	1948	6.53	2075	7.96	2214	9.64	2342	11.4	2471	13.2	
7500	1794	1551	2.36	1619	2.95	1751	4.20	1882	5.64	2015	7.18	2135	8.64	2258	10.3	2386	12.1	2505	13.9	
8000	1913	1645	2.77	1710	3.40	1834	4.72	1953	6.14	2082	7.88	2201	9.40	2310	11.0	2430	12.8			
8500	2033	1740	3.24	1801	3.91	1918	5.28	2033	6.77	2151	8.48	2268	10.2	2376	11.9	2477	13.5			
9000	2153	1835	3.75	1893	4.48	2003	5.90	2115	7.45	2220	9.12	2336	11.1	2443	12.8					
9500	2272	1930	4.33	1986	5.10	2092	6.59	2197	8.20	2297	9.89	2404	11.8	2510	13.8					
10000	2392	2026	4.96	2079	5.78	2181	7.34	2280	9.00	2378	10.7	2474	12.6							

Shaded values show where Class I fan selections are more efficient than Class II.

Inlet Sound Power, L _{Wi} [dB ref 10 ⁻¹² watts]										
RPM	% WOV	1	2	3	4	5	6	7	8	L _{Wi} A
700	100	68	74	67	66	64	62	49	42	69
	80	65	70	64	63	62	60	49	39	66
	60	64	68	62	61	62	61	51	40	66
	50	76	72	68	65	62	60	48	40	68
1000	100	72	80	73	72	70	71	60	51	76
	80	64	75	69	68	67	65	56	48	72
	60	65	74	67	67	66	65	57	49	71
	50	68	74	68	66	65	65	56	49	71
1450	100	79	80	82	81	79	77	79	63	85
	80	73	77	77	76	75	73	67	59	79
	60	75	77	75	73	72	72	67	61	78
	50	78	78	77	74	72	71	67	61	78
2000	100	82	86	91	89	87	85	87	78	93
	80	76	80	85	84	83	80	76	69	87
	60	81	83	85	81	80	78	75	71	86
	50	84	84	85	82	79	78	75	71	85
2517	100	88	89	90	94	94	90	92	87	99
	80	82	85	86	90	91	87	82	76	94
	60	86	87	85	89	87	85	80	76	92
	50	89	90	90	89	87	85	80	77	92

Outlet Sound Power, L _{Wo} [dB ref 10 ⁻¹² watts]										
RPM	% WOV	1	2	3	4	5	6	7	8	L _{Wo} A
700	100	74	76	66	69	67	63	52	43	71
	80	71	73	64	67	66	61	52	44	70
	60	71	72	63	65	65	61	52	45	69
	50	71	72	64	65	65	61	52	46	69
1000	100	80	85	75	76	75	72	63	52	79
	80	75	78	70	74	72	68	60	50	76
	60	76	77	69	71	71	68	60	52	75
	50	78	79	71	71	71	68	60	52	75
1450	100	88	86	84	86	83	79	77	63	88
	80	84	81	78	82	81	75	70	61	84
	60	85	80	78	80	79	74	69	62	83
	50	86	82	79	79	78	74	69	62	82
2000	100	90	90	92	93	91	87	86	80	96
	80	86	87	87	89	89	83	79	73	92
	60	90	88	87	87	87	82	78	73	90
	50	92	90	89	87	86	82	78	73	90
2517	100	95	94	93	97	98	93	92	89	102
	80	90	92	89	93	96	90	86	79	98
	60	95	94	92	90	93	88	85	79	96
	50	97	96	93	92	93	88	84	79	96

Performance certified is for installation type B: Free inlet, Ducted outlet. Power rating (Bhp) does not include transmission losses. Performance ratings do not include the effects of appurtenances (accessories).

The sound power level ratings shown are in decibels, referred to 10⁻¹² watts, calculated per AMCA Standard 301. Values shown are for inlet L_{Wi}, L_{Wi}A and outlet L_{Wo}, L_{Wo}A sound power levels for installation type B: Free inlet, Ducted outlet. Ratings for inlet sound do not include the effects of duct end correction. Ratings for outlet sound include the effects of duct end correction. The A-weighted sound power ratings shown have been calculated per AMCA Standard 301. The AMCA Certified Ratings Seal applies to L_{Wi}A and L_{Wo}A values only.

Performance Data		
Maximum Fan RPM	1839	
Specification Data		
Maximum Motor Frame Size	254T	
Minimum Motor Starting hp	1/3 hp	.25 kW
Wheel Diameter	27 in.	686 mm
Approximate Weight (Less Motor & Drives)	370 lbs.	168 kg.
Maximum Bhp = (Fan RPM / 857) ³		
Outlet Velocity (FPM) = CFM / 5.12		
Tip Speed (FPM) = Fan RPM x 7.07		
% WOV = (CFM x 100) / (Fan RPM x 8.60)		

Imperial data — Metric data

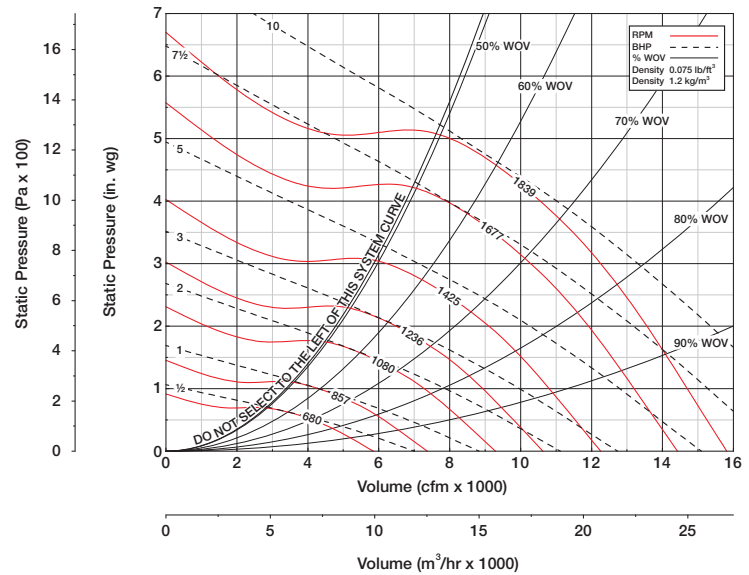

Performance Data

CFM	OV	STATIC PRESSURE (inches wg)																	
		0.25		0.5		1		1.5		2		2.5		3		3.5		4	
		RPM	BHP	RPM	BHP	RPM	BHP	RPM	BHP	RPM	BHP	RPM	BHP	RPM	BHP	RPM	BHP	RPM	BHP
3900	762	564	0.25	662	0.44	837	0.93												
4700	918	641	0.34	725	0.55	883	1.07	1023	1.68										
5500	1075	723	0.45	796	0.69	935	1.25	1066	1.90	1184	2.61	1301	3.38						
6300	1231	806	0.60	872	0.87	997	1.46	1116	2.14	1228	2.90	1329	3.72	1434	4.58				
7100	1388	892	0.79	953	1.08	1065	1.72	1173	2.43	1277	3.22	1376	4.08	1466	4.99	1560	5.94	1650	6.93
7900	1544	979	1.02	1035	1.33	1137	2.01	1236	2.77	1332	3.60	1425	4.49	1515	5.44	1598	6.44	1678	7.47
8700	1700	1068	1.29	1118	1.62	1213	2.35	1305	3.15	1394	4.02	1480	4.94	1564	5.93	1646	6.97	1723	8.05
9500	1857	1156	1.61	1204	1.97	1293	2.75	1377	3.59	1458	4.49	1541	5.46	1619	6.48	1696	7.54	1772	8.67
10300	2013	1246	1.98	1290	2.37	1374	3.20	1451	4.08	1529	5.03	1603	6.03	1680	7.09	1751	8.19	1822	9.34
11100	2170	1335	2.41	1377	2.83	1456	3.70	1530	4.64	1602	5.63	1673	6.67	1742	7.76	1813	8.91		
11900	2326	1426	2.90	1465	3.35	1539	4.27	1610	5.26	1676	6.29	1745	7.38	1809	8.51				
12700	2482	1516	3.46	1554	3.94	1624	4.91	1691	5.95	1755	7.03	1818	8.16						

Inlet Sound Power, L _{Wi} [dB ref 10 ⁻¹² watts]										
RPM	% WOV	1	2	3	4	5	6	7	8	L _{WiA}
450	100	68	69	64	60	59	59	52	38	65
	80	67	68	62	59	57	59	52	38	64
	60	66	67	60	58	56	58	52	38	63
	50	67	68	60	58	55	58	52	38	63
650	100	70	75	70	67	64	65	54	43	70
	80	67	75	68	64	61	61	54	41	68
	60	67	74	65	62	59	60	53	41	66
	50	68	73	65	62	58	60	53	41	66
900	100	73	79	78	74	71	72	61	53	78
	80	69	76	77	71	68	66	58	50	74
	60	70	73	74	68	66	63	56	50	72
	50	72	74	74	67	65	62	55	49	71
1300	100	76	89	85	83	81	78	79	65	87
	80	72	91	83	79	78	75	69	61	83
	60	74	83	79	76	74	71	65	61	79
	50	78	83	79	75	73	69	64	62	78
1839	100	81	86	99	94	91	88	88	77	97
	80	79	82	95	92	87	84	80	72	93
	60	80	82	87	87	84	81	76	71	89
	50	84	84	86	86	82	79	75	71	87

Outlet Sound Power, L _{Wo} [dB ref 10 ⁻¹² watts]										
RPM	% WOV	1	2	3	4	5	6	7	8	L _{WoA}
450	100	71	71	65	64	65	62	56	44	69
	80	71	70	63	63	64	62	57	44	68
	60	69	69	62	62	64	62	57	44	68
	50	72	70	61	61	64	62	57	45	68
650	100	78	75	70	69	67	66	57	47	72
	80	76	74	70	69	67	65	58	47	72
	60	75	74	69	67	66	65	58	48	71
	50	75	74	69	65	65	65	58	48	71
900	100	77	83	77	78	75	73	64	53	80
	80	73	80	74	76	73	69	62	51	78
	60	74	78	72	72	71	67	60	51	75
	50	77	79	72	71	70	66	60	51	74
1300	100	83	84	84	86	85	81	79	64	89
	80	81	82	80	83	82	77	71	60	85
	60	84	81	78	79	77	72	66	59	81
	50	88	83	79	78	76	71	65	60	81
1839	100	87	89	91	96	93	90	88	79	98
	80	86	84	90	92	90	87	82	72	94
	60	91	89	87	89	87	83	78	71	91
	50	94	91	88	88	85	81	76	71	90

Performance certified is for installation type B: Free inlet, Ducted outlet. Power rating (Bhp) does not include transmission losses. Performance ratings do not include the effects of appurtenances (accessories).

The sound power level ratings shown are in decibels, referred to 10⁻¹² watts, calculated per AMCA Standard 301. Values shown are for inlet L_{Wi}, L_{WiA} and outlet L_{Wo}, L_{WoA} sound power levels for installation type B: Free inlet, Ducted outlet. Ratings for inlet sound do not include the effects of duct end correction. Ratings for outlet sound include the effects of duct end correction. The A-weighted sound power ratings shown have been calculated per AMCA Standard 301. The AMCA Certified Ratings Seal applies to L_{WiA} and L_{WoA} values only.

Performance Data		
Maximum Fan RPM	2265	
Specification Data		
Maximum Motor Frame Size	256T	
Minimum Motor Starting hp	1/3 hp	.25 kW
Wheel Diameter	27 in.	686 mm
Approximate Weight (Less Motor & Drives)	420 lbs.	191 kg.
Maximum Bhp = (Fan RPM / 869) ³		
Outlet Velocity (FPM) = CFM / 5.12		
Tip Speed (FPM) = Fan RPM x 7.07		
% WOV = (CFM x 100) / (Fan RPM x 7.17)		

Imperial data — Metric data

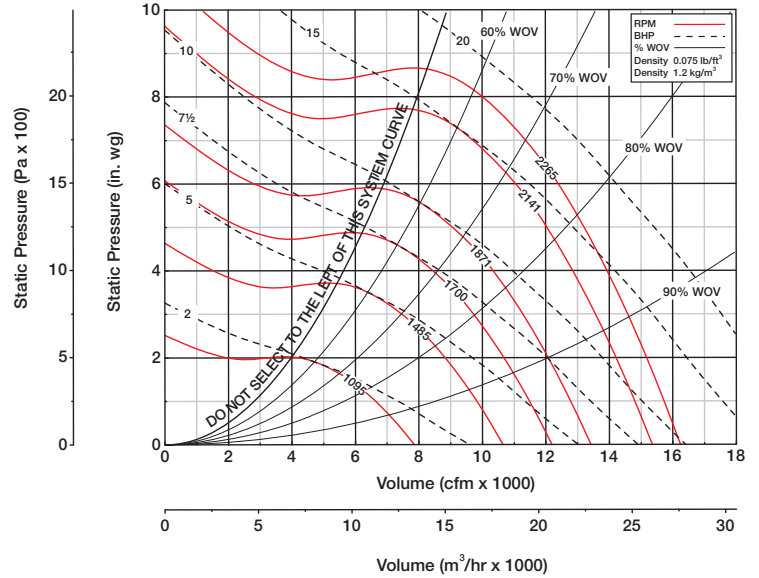

Performance Data

CFM	OV	STATIC PRESSURE (inches wg)																	
		0.5		1		2		3		4		5		6		7		8	
		RPM	BHP	RPM	BHP	RPM	BHP	RPM	BHP	RPM	BHP	RPM	BHP	RPM	BHP	RPM	BHP	RPM	BHP
5600	1093	882	0.81	982	1.29	1174	2.43	1360	3.80										
6200	1210	956	1.00	1045	1.51	1222	2.69	1395	4.11	1564	5.70								
6800	1328	1032	1.22	1115	1.75	1273	2.97	1434	4.43	1588	6.07	1746	7.86						
7400	1445	1109	1.47	1185	2.03	1335	3.32	1480	4.81	1626	6.49	1762	8.32	1912	10.3				
8000	1562	1187	1.76	1257	2.34	1396	3.71	1531	5.22	1666	6.94	1801	8.83	1925	10.8	2065	13.0	2195	15.2
8600	1679	1265	2.09	1331	2.71	1459	4.13	1588	5.69	1714	7.45	1840	9.37	1962	11.4	2078	13.6	2209	15.9
9200	1796	1345	2.46	1407	3.12	1528	4.60	1649	6.23	1764	8.00	1882	9.96	2001	12.1	2113	14.3	2222	16.6
9800	1914	1425	2.87	1483	3.58	1598	5.11	1711	6.81	1820	8.61	1932	10.6	2040	12.8	2152	15.0	2257	17.4
10400	2031	1505	3.33	1560	4.10	1668	5.68	1773	7.45	1881	9.32	1982	11.3	2088	13.5	2192	15.8		
11000	2148	1586	3.84	1637	4.66	1740	6.29	1841	8.13	1942	10.1	2039	12.1	2138	14.3	2237	16.7		
11600	2265	1667	4.40	1715	5.28	1813	6.96	1910	8.87	2005	10.9	2100	13.0	2189	15.2				
12200	2382	1749	5.02	1794	5.96	1888	7.72	1980	9.66	2068	11.8	2161	13.9	2249	16.2				

Shaded values show where Class I fan selections are more efficient than Class II.

Inlet Sound Power, L _{Wi} [dB ref 10 ⁻¹² watts]										
RPM	% WOV	1	2	3	4	5	6	7	8	L _{WiA}
650	100	66	75	70	65	63	64	51	43	70
	80	64	72	67	62	62	59	51	41	67
	60	64	70	65	60	60	59	51	41	65
	50	67	72	66	61	60	59	52	41	66
900	100	70	79	73	71	69	73	60	52	77
	80	68	73	69	66	66	66	59	49	72
	60	70	71	69	66	65	65	59	50	71
	50	73	75	70	66	65	65	59	50	71
1300	100	75	80	89	82	79	76	79	63	86
	80	71	76	85	79	76	73	68	60	82
	60	75	76	80	76	74	71	66	61	79
	50	79	83	86	76	73	71	66	61	81
1800	100	81	85	93	89	88	84	87	78	94
	80	76	79	90	85	85	81	77	69	89
	60	82	82	87	83	82	78	74	70	87
	50	85	87	90	83	81	78	74	70	87
2265	100	85	88	94	95	94	91	91	89	99
	80	79	82	89	91	91	87	83	76	95
	60	85	87	88	88	87	84	80	77	91
	50	87	92	93	89	87	83	80	77	92

Outlet Sound Power, L _{Wo} [dB ref 10 ⁻¹² watts]										
RPM	% WOV	1	2	3	4	5	6	7	8	L _{WoA}
650	100	74	79	68	69	66	64	55	45	72
	80	73	78	66	67	65	64	59	49	71
	60	73	77	65	65	64	63	59	48	70
	50	75	78	66	65	64	63	58	47	70
900	100	77	80	74	75	72	72	64	54	78
	80	73	76	70	73	71	68	63	52	76
	60	74	76	70	71	69	68	63	53	74
	50	81	79	71	71	70	68	64	54	75
1300	100	82	84	85	86	82	77	78	67	88
	80	79	79	80	84	80	75	71	65	85
	60	81	82	80	81	78	74	70	65	83
	50	82	84	80	81	77	74	70	65	83
1800	100	87	89	92	92	91	86	86	80	95
	80	82	86	88	92	89	84	80	71	93
	60	86	90	89	88	86	81	79	72	91
	50	88	91	90	88	86	81	79	72	91
2265	100	92	94	96	98	96	92	91	90	101
	80	87	88	92	93	92	89	85	78	96
	60	92	93	92	92	91	87	83	77	95
	50	93	94	93	92	91	87	83	78	95

Performance certified is for installation type B: Free inlet, Ducted outlet. Power rating (Bhp) does not include transmission losses. Performance ratings do not include the effects of appurtenances (accessories).

The sound power level ratings shown are in decibels, referred to 10⁻¹² watts, calculated per AMCA Standard 301. Values shown are for inlet L_{Wi}, L_{WiA} and outlet L_{Wo}, L_{WoA} sound power levels for installation type B: Free inlet, Ducted outlet. Ratings for inlet sound do not include the effects of duct end correction. Ratings for outlet sound include the effects of duct end correction. The A-weighted sound power ratings shown have been calculated per AMCA Standard 301. The AMCA Certified Ratings Seal applies to L_{WiA} and L_{WoA} values only.

Performance Data		
Maximum Fan RPM	1655	
Specification Data		
Maximum Motor Frame Size	254T	
Minimum Motor Starting hp	1/3 hp	.25 kW
Wheel Diameter	30 in.	762 mm
Approximate Weight (Less Motor & Drives)	470 lbs.	213 kg.
Maximum Bhp = (Fan RPM / 719) ³		
Outlet Velocity (FPM) = CFM / 6.21		
Tip Speed (FPM) = Fan RPM x 7.85		
% WOV = (CFM x 100) / (Fan RPM x 11.8)		

Imperial data — Metric data

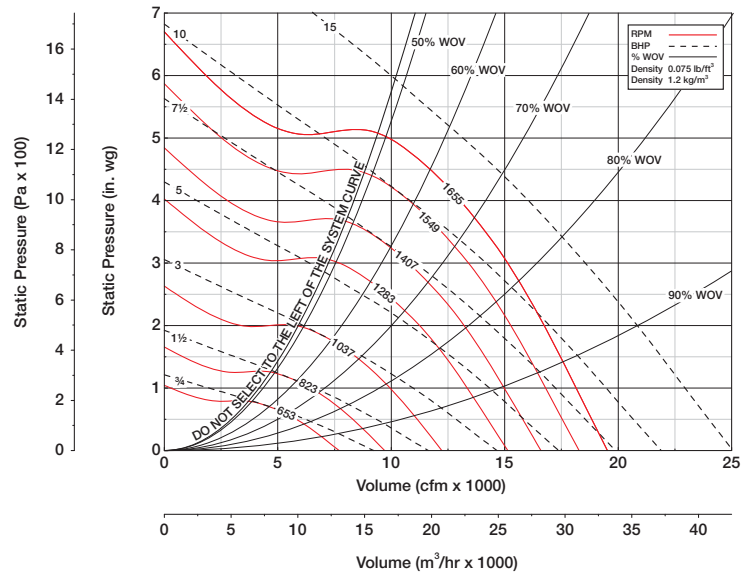

Performance Data

CFM	OV	STATIC PRESSURE (inches wg)																	
		0.25		0.5		1		1.5		2		2.5		3		3.5		4	
		RPM	BHP	RPM	BHP	RPM	BHP	RPM	BHP	RPM	BHP	RPM	BHP	RPM	BHP	RPM	BHP	RPM	BHP
4600	740	494	0.28	584	0.52	748	1.11												
5600	901	563	0.39	640	0.65	786	1.29	915	2.02										
6600	1062	636	0.53	704	0.82	831	1.50	951	2.29	1060	3.16								
7600	1223	712	0.71	772	1.03	888	1.76	996	2.59	1097	3.52	1191	4.51	1286	5.56				
8600	1384	790	0.93	845	1.28	948	2.06	1047	2.94	1142	3.91	1231	4.96	1312	6.07	1400	7.24	1481	8.45
9600	1545	869	1.21	920	1.59	1013	2.42	1103	3.35	1190	4.36	1276	5.46	1357	6.63	1431	7.85	1507	9.12
10600	1706	949	1.54	996	1.95	1082	2.84	1165	3.82	1247	4.88	1324	6.02	1402	7.23	1475	8.51	1545	9.83
11600	1867	1030	1.93	1073	2.37	1154	3.33	1231	4.36	1304	5.46	1380	6.65	1450	7.90	1521	9.22	1589	10.6
12600	2028	1112	2.39	1152	2.86	1228	3.88	1298	4.96	1369	6.13	1436	7.35	1506	8.66	1570	10.0	1635	11.4
13600	2190	1193	2.91	1231	3.43	1303	4.50	1369	5.65	1435	6.87	1499	8.15	1562	9.49	1626	10.9		
14600	2351	1275	3.52	1311	4.07	1378	5.21	1442	6.42	1502	7.69	1564	9.03	1623	10.4				
15600	2512	1358	4.21	1392	4.80	1455	6.00	1516	7.27	1574	8.60	1631	9.99						

Inlet Sound Power, L _{Wi} [dB ref 10 ⁻¹² watts]										
RPM	% WOV	1	2	3	4	5	6	7	8	L _{Wi} A
400	100	69	69	64	61	60	58	50	36	65
	80	68	68	62	59	58	58	50	36	64
	60	66	67	60	58	57	58	50	37	63
	50	67	67	60	58	56	58	50	36	63
600	100	72	76	71	68	65	65	55	43	71
	80	70	75	69	65	62	61	54	41	69
	60	69	75	66	63	60	61	53	41	67
	50	71	74	66	63	60	61	53	41	67
850	100	76	81	80	76	73	73	62	55	79
	80	72	79	79	73	70	67	59	51	76
	60	72	75	76	69	67	65	57	51	73
	50	74	77	76	68	66	63	57	51	73
1150	100	79	91	85	83	81	79	77	63	87
	80	76	92	83	80	78	74	68	60	83
	60	76	85	79	76	74	70	65	61	79
	50	79	84	79	75	73	69	64	63	78
1655	100	83	89	100	95	91	89	87	76	97
	80	80	85	95	92	88	85	80	72	94
	60	81	84	88	88	84	81	76	71	89
	50	85	85	87	86	82	79	75	71	88

Outlet Sound Power, L _{Wo} [dB ref 10 ⁻¹² watts]										
RPM	% WOV	1	2	3	4	5	6	7	8	L _{Wo} A
400	100	72	71	65	65	65	62	55	43	69
	80	72	70	63	64	64	62	55	43	68
	60	70	69	63	63	64	62	55	43	68
	50	72	69	62	63	64	62	56	43	68
600	100	79	76	72	71	68	67	58	47	73
	80	77	75	71	70	68	66	58	47	73
	60	77	75	70	68	67	66	58	48	72
	50	77	75	70	67	66	65	59	48	72
850	100	80	84	79	80	77	75	65	54	82
	80	76	81	76	78	75	70	63	52	79
	60	77	79	74	74	73	68	61	52	77
	50	79	80	74	73	72	68	61	52	76
1150	100	83	85	85	86	84	81	77	62	89
	80	82	83	81	83	81	76	69	59	85
	60	84	82	78	79	77	72	65	58	81
	50	87	84	79	79	76	71	65	59	81
1655	100	88	90	92	96	94	91	88	78	98
	80	87	86	91	92	90	87	81	71	94
	60	91	89	88	90	87	83	78	70	91
	50	94	91	89	89	86	81	76	71	90

Performance certified is for installation type B: Free inlet, Ducted outlet. Power rating (Bhp) does not include transmission losses. Performance ratings do not include the effects of appurtenances (accessories).

The sound power level ratings shown are in decibels, referred to 10⁻¹² watts, calculated per AMCA Standard 301. Values shown are for inlet L_{Wi}, L_{Wi}A and outlet L_{Wo}, L_{Wo}A sound power levels for installation type B: Free inlet, Ducted outlet. Ratings for inlet sound do not include the effects of duct end correction. Ratings for outlet sound include the effects of duct end correction. The A-weighted sound power ratings shown have been calculated per AMCA Standard 301. The AMCA Certified Ratings Seal applies to L_{Wi}A and L_{Wo}A values only.

Performance Data		
Maximum Fan RPM	2036	
Specification Data		
Maximum Motor Frame Size	284T	
Minimum Motor Starting hp	3/4 hp	.55 kW
Wheel Diameter	30 in.	762 mm
Approximate Weight (Less Motor & Drives)	550 lbs.	249 kg.
Maximum Bhp = (Fan RPM / 729) ³		
Outlet Velocity (FPM) = CFM / 6.21		
Tip Speed (FPM) = Fan RPM x 7.85		
% WOV = (CFM x 100) / (Fan RPM x 9.84)		

Imperial data — Metric data

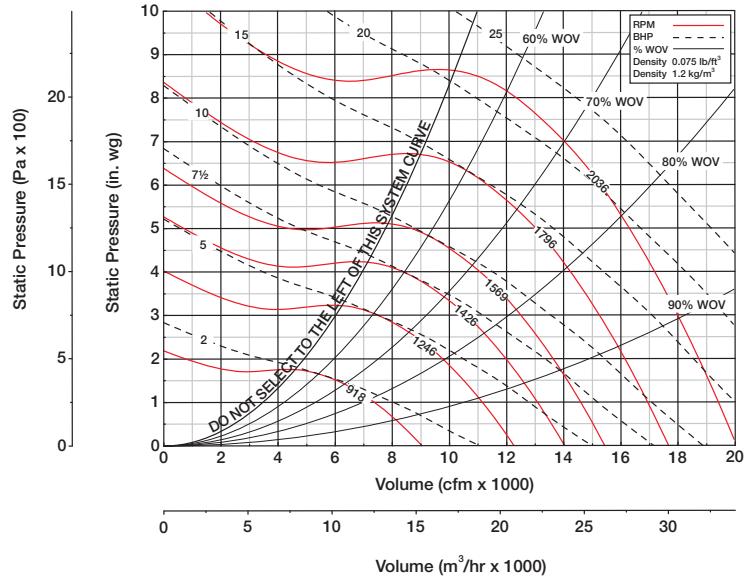

Performance Data

CFM	OV	STATIC PRESSURE (inches wg)																	
		0.5		1		2		3		4		5		6		7		8	
		RPM	BHP	RPM	BHP	RPM	BHP	RPM	BHP	RPM	BHP	RPM	BHP	RPM	BHP	RPM	BHP	RPM	BHP
6800	1075	784	0.97	875	1.56	1051	2.96	1222	4.64										
7500	1186	847	1.18	928	1.80	1090	3.25	1248	4.99	1405	6.94								
8200	1297	911	1.43	987	2.08	1133	3.57	1281	5.36	1420	7.37	1568	9.57						
8900	1408	976	1.71	1046	2.39	1184	3.96	1318	5.78	1453	7.85	1580	10.1	1717	12.5				
9600	1518	1042	2.03	1107	2.74	1236	4.39	1360	6.25	1486	8.36	1607	10.7	1728	13.1	1854	15.7		
10300	1629	1108	2.40	1169	3.15	1289	4.87	1405	6.76	1523	8.92	1641	11.3	1751	13.8	1865	16.5	1983	19.3
11000	1740	1176	2.81	1233	3.60	1345	5.39	1457	7.36	1566	9.54	1674	11.9	1784	14.5	1885	17.2	1994	20.1
11700	1851	1244	3.26	1298	4.11	1404	5.97	1509	8.02	1609	10.2	1714	12.7	1817	15.3	1918	18.1	2013	21.0
12400	1962	1312	3.76	1363	4.67	1464	6.59	1562	8.72	1660	11.0	1757	13.5	1853	16.1	1951	19.0		
13100	2072	1380	4.32	1428	5.29	1524	7.27	1617	9.48	1712	11.8	1800	14.3	1895	17.0	1985	19.9		
13800	2183	1449	4.94	1494	5.97	1585	8.00	1675	10.3	1765	12.7	1851	15.3	1938	18.0	2026	20.9		
14500	2294	1518	5.61	1561	6.72	1648	8.82	1734	11.2	1818	13.7	1903	16.3	1982	19.0				

Shaded values show where Class I fan selections are more efficient than Class II.

Inlet Sound Power, L _{Wi} [dB ref 10 ⁻¹² watts]										
RPM	% WOV	1	2	3	4	5	6	7	8	L _{Wi} A
600	100	69	76	71	66	65	64	52	43	71
	80	67	73	68	64	63	59	51	41	68
	60	66	71	66	61	61	59	51	41	66
	50	69	73	67	62	62	60	52	41	67
850	100	73	81	75	73	71	74	61	53	78
	80	71	76	71	70	68	67	60	50	74
	60	72	74	71	68	67	67	61	51	73
	50	76	78	72	68	67	67	60	51	73
1150	100	76	82	88	82	79	77	77	61	86
	80	72	78	85	79	76	73	67	59	82
	60	76	77	80	76	74	71	66	60	79
	50	80	84	85	76	73	71	66	61	81
1650	100	83	87	95	90	89	86	87	78	95
	80	78	82	92	86	86	82	77	69	91
	60	84	84	89	84	83	79	75	71	88
	50	86	89	91	84	82	78	75	71	88
2036	100	86	89	96	96	95	91	92	90	100
	80	80	84	91	92	92	88	83	76	95
	60	87	88	89	89	88	84	80	77	92
	50	89	94	94	89	87	84	80	77	93

Outlet Sound Power, L _{Wo} [dB ref 10 ⁻¹² watts]										
RPM	% WOV	1	2	3	4	5	6	7	8	L _{Wo} A
600	100	76	79	70	70	67	65	56	45	73
	80	76	78	68	68	67	65	59	49	72
	60	75	77	67	67	66	64	59	49	71
	50	76	78	67	66	65	64	59	47	71
850	100	79	82	76	77	74	74	65	55	80
	80	75	78	73	75	73	70	64	53	77
	60	76	79	72	73	71	69	65	54	76
	50	83	81	73	73	71	69	65	55	77
1150	100	83	84	86	86	82	78	77	65	87
	80	80	80	81	83	80	75	71	64	84
	60	81	82	81	81	78	74	70	65	83
	50	83	83	81	81	77	74	70	65	82
1650	100	88	90	94	94	92	87	87	81	96
	80	84	87	90	93	90	84	80	72	94
	60	88	91	91	89	87	82	79	72	92
	50	89	92	91	89	87	82	80	73	92
2036	100	94	95	97	99	97	93	92	91	102
	80	88	89	93	94	93	89	85	77	97
	60	93	94	93	93	91	87	83	77	95
	50	94	95	94	93	91	87	83	78	96

Performance certified is for installation type B: Free inlet, Ducted outlet. Power rating (Bhp) does not include transmission losses. Performance ratings do not include the effects of appurtenances (accessories).

The sound power level ratings shown are in decibels, referred to 10⁻¹² watts, calculated per AMCA Standard 301. Values shown are for inlet L_{Wi}, L_{Wi}A and outlet L_{Wo}, L_{Wo}A sound power levels for installation type B: Free inlet, Ducted outlet. Ratings for inlet sound do not include the effects of duct end correction. Ratings for outlet sound include the effects of duct end correction. The A-weighted sound power ratings shown have been calculated per AMCA Standard 301. The AMCA Certified Ratings Seal applies to L_{Wi}A and L_{Wo}A values only.

Performance Data		
Maximum Fan RPM	1505	
Specification Data		
Maximum Motor Frame Size	256T	
Minimum Motor Starting hp	3/4 hp	.55 kW
Wheel Diameter	33 in.	838 mm
Approximate Weight (Less Motor & Drives)	540 lbs.	245 kg.
Maximum Bhp = (Fan RPM / 626) ³		
Outlet Velocity (FPM) = CFM / 7.54		
Tip Speed (FPM) = Fan RPM x 8.64		
% WOV = (CFM x 100) / (Fan RPM x 15.2)		

Imperial data — Metric data

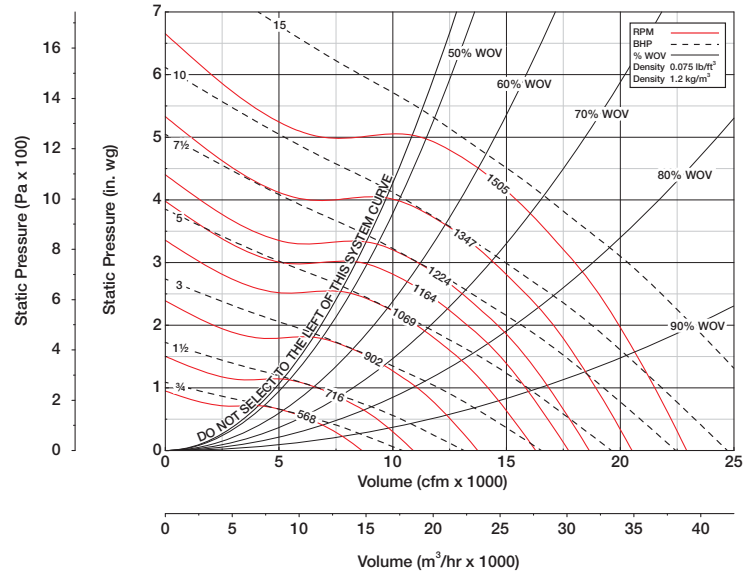

Performance Data

CFM	OV	STATIC PRESSURE (inches wg)																	
		0.25		0.5		1		1.5		2		2.5		3		3.5		4	
		RPM	BHP	RPM	BHP	RPM	BHP	RPM	BHP	RPM	BHP	RPM	BHP	RPM	BHP	RPM	BHP	RPM	BHP
5700	755	459	0.35	541	0.63	690	1.32												
6900	915	524	0.48	594	0.79	724	1.53	843	2.40	950	3.36								
8100	1074	593	0.65	651	0.98	767	1.79	875	2.72	976	3.75	1070	4.85						
9300	1233	664	0.87	716	1.24	819	2.10	916	3.08	1009	4.17	1097	5.34	1182	6.58	1260	7.88		
10500	1392	737	1.14	783	1.54	875	2.46	964	3.51	1050	4.64	1131	5.87	1208	7.17	1287	8.55	1359	9.98
11700	1551	811	1.47	853	1.91	933	2.88	1017	3.99	1096	5.19	1172	6.46	1246	7.83	1314	9.26	1386	10.8
12900	1710	886	1.88	924	2.35	999	3.38	1073	4.54	1148	5.81	1218	7.14	1287	8.55	1355	10.0	1418	11.6
14100	1870	962	2.35	997	2.86	1065	3.96	1131	5.15	1202	6.50	1269	7.90	1332	9.36	1396	10.9	1459	12.5
15300	2029	1038	2.91	1070	3.46	1133	4.62	1196	5.88	1259	7.25	1322	8.74	1384	10.3	1442	11.9	1500	13.5
16500	2188	1114	3.55	1144	4.14	1203	5.37	1262	6.70	1318	8.10	1379	9.64	1436	11.3	1494	12.9		
17700	2347	1191	4.29	1219	4.92	1275	6.23	1329	7.61	1383	9.08	1436	10.6	1492	12.3				
18900	2506	1268	5.13	1294	5.80	1346	7.18	1397	8.62	1449	10.2	1497	11.8						

Inlet Sound Power, L _{Wi} [dB ref 10 ⁻¹² watts]										
RPM	% WOV	1	2	3	4	5	6	7	8	L _{Wi} A
400	100	70	71	64	59	61	58	52	38	65
	80	65	68	62	58	57	58	52	40	64
	60	65	67	62	59	57	58	52	42	63
	50	67	68	61	58	57	58	53	42	64
550	100	73	72	70	65	65	67	54	45	71
	80	70	70	67	63	61	61	54	44	67
	60	69	69	64	61	60	60	55	44	66
	50	74	70	64	61	60	60	54	44	66
750	100	84	83	75	73	70	76	62	54	79
	80	82	80	73	70	69	66	60	53	74
	60	79	77	71	68	67	64	59	52	72
	50	79	78	71	67	66	63	59	52	71
1100	100	77	86	86	84	80	78	82	66	88
	80	73	84	83	80	77	74	70	63	83
	60	75	84	79	76	75	72	67	64	80
	50	79	82	82	76	74	71	66	64	80
1505	100	80	89	92	93	89	85	90	76	95
	80	78	87	88	90	86	83	79	72	91
	60	81	90	88	86	83	80	77	72	89
	50	85	89	89	86	82	80	76	73	88

Outlet Sound Power, L _{Wo} [dB ref 10 ⁻¹² watts]										
RPM	% WOV	1	2	3	4	5	6	7	8	L _{Wo} A
400	100	70	70	65	67	62	60	55	44	68
	80	69	68	63	65	59	61	57	45	67
	60	69	69	63	64	59	61	57	45	67
	50	68	68	62	64	59	61	56	45	66
550	100	78	73	71	71	67	67	56	46	73
	80	75	71	68	69	65	65	57	47	71
	60	74	70	67	67	65	64	57	47	70
	50	73	71	66	66	64	64	56	46	70
750	100	85	82	77	79	74	75	64	55	81
	80	85	80	75	76	72	68	62	53	78
	60	83	79	74	75	71	67	61	53	76
	50	83	79	74	73	71	66	61	52	75
1100	100	85	89	86	89	84	81	82	66	90
	80	81	86	82	86	81	77	72	63	86
	60	84	87	81	83	78	75	69	63	84
	50	87	88	83	82	78	74	68	64	84
1505	100	88	91	93	97	93	89	89	79	99
	80	86	89	90	94	90	87	83	73	95
	60	91	89	88	91	87	84	81	72	92
	50	93	92	90	92	87	83	80	72	93

Performance certified is for installation type B: Free inlet, Ducted outlet. Power rating (Bhp) does not include transmission losses. Performance ratings do not include the effects of appurtenances (accessories).

The sound power level ratings shown are in decibels, referred to 10⁻¹² watts, calculated per AMCA Standard 301. Values shown are for inlet L_{Wi}, L_{Wi}A and outlet L_{Wo}, L_{Wo}A sound power levels for installation type B: Free inlet, Ducted outlet. Ratings for inlet sound do not include the effects of duct end correction. Ratings for outlet sound include the effects of duct end correction. The A-weighted sound power ratings shown have been calculated per AMCA Standard 301. The AMCA Certified Ratings Seal applies to L_{Wi}A and L_{Wo}A values only.

Performance Data		
Maximum Fan RPM	1847	
Specification Data		
Maximum Motor Frame Size	286T	
Minimum Motor Starting hp	1½ hp	1.1 kW
Wheel Diameter	33 in.	838 mm
Approximate Weight (Less Motor & Drives)	670 lbs.	304 kg.
Maximum Bhp = (Fan RPM / 630) ³		
Outlet Velocity (FPM) = CFM / 7.54		
Tip Speed (FPM) = Fan RPM x 8.64		
% WOV = (CFM x 100) / (Fan RPM x 12.9)		

Imperial data — Metric data

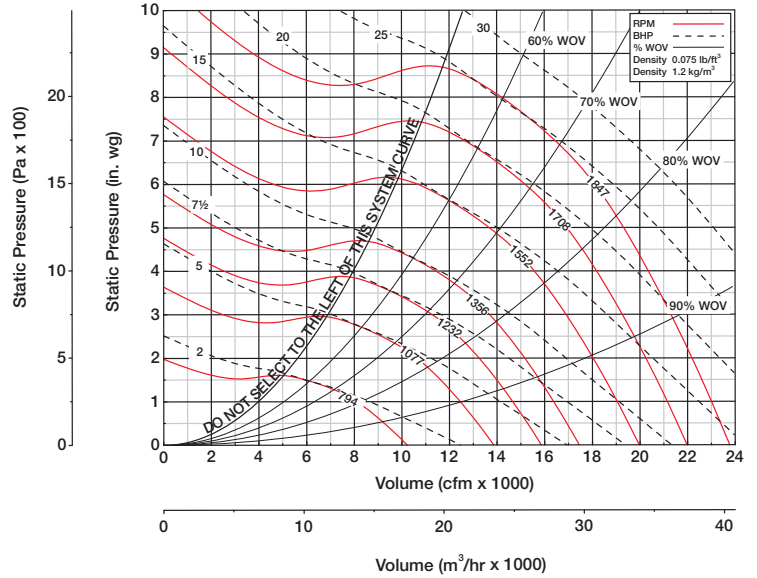

Performance Data

CFM	OV	STATIC PRESSURE (inches wg)																	
		0.5		1		2		3		4		5		6		7		8	
		RPM	BHP	RPM	BHP	RPM	BHP	RPM	BHP	RPM	BHP	RPM	BHP	RPM	BHP	RPM	BHP	RPM	BHP
8300	1100	727	1.21	807	1.89	967	3.57	1119	5.59	1265	7.80								
9100	1206	782	1.45	854	2.16	1002	3.91	1147	5.98	1281	8.29	1410	10.8						
9900	1312	839	1.73	906	2.49	1038	4.28	1175	6.41	1303	8.81	1427	11.4	1543	14.1				
10700	1419	896	2.05	959	2.87	1082	4.71	1207	6.89	1331	9.34	1444	12.0	1560	14.8	1667	17.8		
11500	1525	953	2.41	1012	3.28	1128	5.19	1243	7.42	1359	9.91	1472	12.7	1576	15.6	1684	18.6	1783	21.8
12300	1631	1011	2.82	1067	3.75	1174	5.71	1280	7.99	1392	10.6	1500	13.4	1602	16.4	1700	19.5	1800	22.7
13100	1737	1070	3.28	1123	4.26	1223	6.30	1325	8.65	1428	11.3	1529	14.1	1630	17.2	1723	20.4	1816	23.8
13900	1843	1130	3.78	1179	4.82	1275	6.97	1371	9.36	1464	12.0	1563	14.9	1658	18.0	1752	21.3	1839	24.8
14700	1949	1189	4.35	1236	5.44	1327	7.69	1417	10.1	1506	12.8	1599	15.8	1688	18.9	1780	22.3		
15500	2055	1249	4.97	1293	6.12	1380	8.48	1464	11.0	1551	13.8	1635	16.7	1724	20.0	1809	23.3		
16300	2161	1309	5.65	1351	6.86	1434	9.33	1515	11.9	1597	14.7	1676	17.8	1760	21.0	1843	24.5		
17100	2267	1370	6.39	1409	7.67	1488	10.2	1566	12.9	1644	15.8	1721	18.9	1797	22.2				

Shaded values show where Class I fan selections are more efficient than Class II.

Inlet Sound Power, L _{Wi} [dB ref 10 ⁻¹² watts]										
RPM	% WOV	1	2	3	4	5	6	7	8	L _{Wi} A
550	100	81	72	67	64	68	62	50	43	71
	80	79	71	64	62	62	58	50	44	67
	60	76	68	62	61	62	59	51	45	66
	50	74	68	63	61	62	59	51	45	66
750	100	73	80	75	72	71	77	58	53	79
	80	65	73	71	68	68	62	56	49	72
	60	67	70	70	65	67	62	56	50	71
	50	68	71	69	65	67	62	56	51	70
1100	100	78	90	84	83	81	83	78	65	88
	80	74	89	80	79	78	73	67	61	82
	60	74	84	76	75	77	72	67	62	80
	50	78	83	77	74	76	71	67	63	80
1500	100	83	86	95	91	89	86	89	75	95
	80	78	80	91	87	85	80	76	70	89
	60	80	80	87	83	82	79	75	71	87
	50	83	83	86	83	81	78	75	72	86
1847	100	85	90	97	97	96	92	94	84	101
	80	82	83	91	92	92	87	84	77	96
	60	89	86	90	89	89	85	82	78	93
	50	89	89	91	89	88	84	81	78	92

Outlet Sound Power, L _{Wo} [dB ref 10 ⁻¹² watts]										
RPM	% WOV	1	2	3	4	5	6	7	8	L _{Wo} A
550	100	83	74	70	71	68	64	55	45	73
	80	82	72	67	70	66	62	56	45	71
	60	79	69	65	68	65	62	56	45	70
	50	79	70	65	67	65	62	56	45	70
750	100	79	81	78	79	74	75	62	55	81
	80	76	76	75	77	72	67	61	53	77
	60	75	73	72	74	71	66	61	52	75
	50	77	75	71	73	70	66	61	53	75
1100	100	85	92	88	89	84	84	78	67	91
	80	81	84	84	86	82	77	69	62	87
	60	83	82	81	83	79	75	68	63	84
	50	84	84	81	82	79	74	68	64	84
1500	100	90	91	96	96	92	89	90	77	98
	80	85	86	91	94	89	85	79	72	95
	60	89	88	88	91	87	82	77	72	92
	50	91	90	90	90	86	82	77	73	91
1847	100	96	95	100	101	99	94	94	86	103
	80	91	90	98	98	96	91	86	79	100
	60	97	94	94	95	93	88	83	79	97
	50	97	96	96	95	92	88	83	79	97

Performance certified is for installation type B: Free inlet, Ducted outlet. Power rating (Bhp) does not include transmission losses. Performance ratings do not include the effects of appurtenances (accessories).

The sound power level ratings shown are in decibels, referred to 10⁻¹² watts, calculated per AMCA Standard 301. Values shown are for inlet L_{Wi}, L_{Wi}A and outlet L_{Wo}, L_{Wo}A sound power levels for installation type B: Free inlet, Ducted outlet. Ratings for inlet sound do not include the effects of duct end correction. Ratings for outlet sound include the effects of duct end correction. The A-weighted sound power ratings shown have been calculated per AMCA Standard 301. The AMCA Certified Ratings Seal applies to L_{Wi}A and L_{Wo}A values only.

Performance Data		
Maximum Fan RPM	1360	
Specification Data		
Maximum Motor Frame Size	284T	
Minimum Motor Starting hp	1 hp	.75 kW
Wheel Diameter	36.5 in.	927 mm
Approximate Weight (Less Motor & Drives)	850 lbs.	386 kg.
Maximum Bhp = (Fan RPM / 528) ³		
Outlet Velocity (FPM) = CFM / 9.31		
Tip Speed (FPM) = Fan RPM x 9.56		
% WOV = (CFM x 100) / (Fan RPM x 20.6)		

Imperial data — Metric data

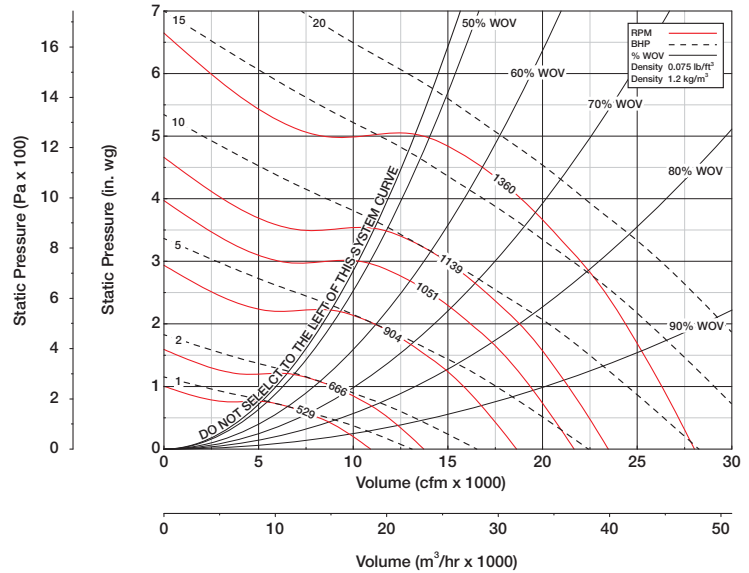

Performance Data

CFM	OV	STATIC PRESSURE (inches wg)																	
		0.25		0.5		1		1.5		2		2.5		3		3.5		4	
		RPM	BHP	RPM	BHP	RPM	BHP	RPM	BHP	RPM	BHP	RPM	BHP	RPM	BHP	RPM	BHP	RPM	BHP
6900	748	412	0.42	487	0.76	622	1.60												
8400	910	472	0.58	536	0.96	654	1.87	761	2.93	858	4.10								
9900	1073	536	0.79	588	1.20	693	2.19	791	3.32	882	4.58	968	5.93						
11400	1235	602	1.07	648	1.52	742	2.58	829	3.77	912	5.10	992	6.54	1069	8.06	1140	9.65		
12900	1398	669	1.41	710	1.9	793	3.03	874	4.31	950	5.70	1024	7.21	1093	8.80	1164	10.5	1230	12.2
14400	1561	737	1.83	775	2.37	847	3.55	923	4.92	993	6.39	1062	7.95	1128	9.63	1190	11.4	1254	13.2
15900	1723	806	2.34	841	2.92	908	4.19	975	5.61	1042	7.17	1104	8.80	1167	10.5	1228	12.4	1285	14.3
17400	1886	876	2.94	908	3.57	969	4.92	1028	6.39	1092	8.04	1152	9.77	1209	11.6	1266	13.4	1323	15.4
18900	2048	947	3.65	975	4.33	1032	5.76	1088	7.31	1145	8.99	1202	10.8	1257	12.7	1310	14.7		
20400	2211	1018	4.47	1044	5.20	1097	6.72	1150	8.35	1200	10.1	1254	12.0	1306	14.0	1358	16.0		
21900	2374	1088	5.41	1113	6.19	1163	7.81	1212	9.51	1260	11.3	1307	13.2	1358	15.3				
23400	2536	1160	6.49	1183	7.32	1230	9.03	1275	10.8	1321	12.7								

Inlet Sound Power, L _{Wi} [dB ref 10 ⁻¹² watts]										
RPM	% WOV	1	2	3	4	5	6	7	8	L _{Wi} A
350	100	70	70	63	60	61	57	49	36	65
	80	66	67	61	58	57	57	50	38	63
	60	66	66	61	58	57	57	51	40	63
	50	67	67	61	58	57	57	51	40	63
500	100	74	73	70	66	66	67	54	44	72
	80	71	71	68	64	62	61	54	43	68
	60	70	70	65	62	61	60	54	44	67
	50	74	71	65	62	61	60	54	43	66
700	100	87	84	77	74	73	76	62	55	80
	80	84	81	74	72	70	67	61	53	75
	60	81	78	72	69	68	65	60	53	73
	50	81	79	73	68	67	64	60	53	73
950	100	78	86	85	83	79	79	79	62	86
	80	75	84	82	79	77	73	68	61	82
	60	77	83	78	76	74	71	67	63	79
	50	79	82	81	76	73	70	66	63	79
1360	100	83	91	93	93	89	87	88	75	96
	80	80	89	90	90	86	83	79	72	92
	60	84	91	89	86	84	81	77	73	89
	50	87	91	89	86	83	80	76	73	89

Outlet Sound Power, L _{Wo} [dB ref 10 ⁻¹² watts]										
RPM	% WOV	1	2	3	4	5	6	7	8	L _{Wo} A
350	100	70	69	66	66	62	59	53	42	68
	80	69	68	64	64	60	60	55	43	66
	60	69	68	63	63	59	60	55	43	66
	50	68	67	63	63	59	60	54	43	66
500	100	78	74	72	72	68	67	56	46	74
	80	76	71	69	70	66	65	56	46	72
	60	75	71	68	68	66	64	56	46	71
	50	74	71	67	67	65	64	56	46	70
700	100	87	83	79	80	75	76	64	55	82
	80	87	81	76	78	73	69	63	54	79
	60	85	80	75	76	72	68	62	53	77
	50	85	80	75	75	72	67	61	53	77
950	100	86	89	86	88	84	81	79	63	89
	80	82	85	83	85	80	76	70	61	85
	60	84	86	82	82	77	73	68	62	83
	50	87	87	83	81	77	72	67	63	83
1360	100	89	92	95	97	93	90	89	78	99
	80	87	90	91	94	90	87	82	72	95
	60	92	91	89	91	87	85	81	72	93
	50	94	93	91	92	87	84	80	71	93

Performance certified is for installation type B: Free inlet, Ducted outlet. Power rating (Bhp) does not include transmission losses. Performance ratings do not include the effects of appurtenances (accessories).

The sound power level ratings shown are in decibels, referred to 10⁻¹² watts, calculated per AMCA Standard 301. Values shown are for inlet L_{Wi}, L_{Wi}A and outlet L_{Wo}, L_{Wo}A sound power levels for installation type B: Free inlet, Ducted outlet. Ratings for inlet sound do not include the effects of duct end correction. Ratings for outlet sound include the effects of duct end correction. The A-weighted sound power ratings shown have been calculated per AMCA Standard 301. The AMCA Certified Ratings Seal applies to L_{Wi}A and L_{Wo}A values only.

Performance Data		
Maximum Fan RPM	1670	
Specification Data		
Maximum Motor Frame Size	324T	
Minimum Motor Starting hp	1½ hp	1.1 kW
Wheel Diameter	36.5 in.	927 mm
Approximate Weight (Less Motor & Drives)	1000 lbs.	454 kg.
Maximum Bhp = (Fan RPM / 533) ³		
Outlet Velocity (FPM) = CFM / 9.31		
Tip Speed (FPM) = Fan RPM x 9.56		
% WOV = (CFM x 100) / (Fan RPM x 17.4)		

Imperial data — Metric data

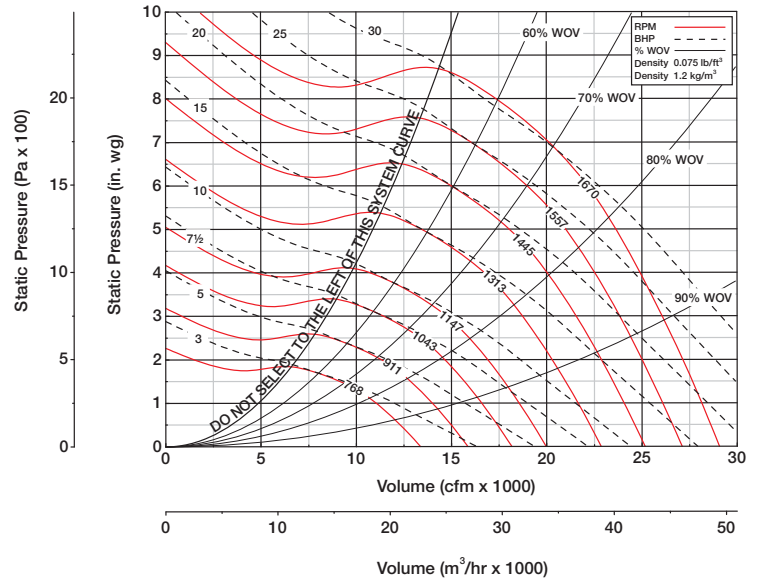

Performance Data

CFM	OV	STATIC PRESSURE (inches wg)																	
		0.5		1		2		3		4		5		6		7		8	
		RPM	BHP	RPM	BHP	RPM	BHP	RPM	BHP	RPM	BHP	RPM	BHP	RPM	BHP	RPM	BHP	RPM	BHP
10000	1084	650	1.43	723	2.26	870	4.31	1009	6.76	1141	9.50								
11100	1203	706	1.76	771	2.63	905	4.77	1036	7.30	1158	10.1	1274	13.1						
12200	1323	763	2.15	824	3.09	942	5.28	1065	7.89	1180	10.8	1291	14.0	1397	17.3				
13300	1442	821	2.60	877	3.61	987	5.88	1098	8.56	1209	11.6	1311	14.9	1413	18.3	1510	21.9		
14400	1561	880	3.11	931	4.20	1034	6.56	1135	9.31	1237	12.4	1339	15.8	1431	19.4	1527	23.1	1617	27.0
15500	1681	939	3.70	988	4.86	1082	7.31	1176	10.1	1273	13.3	1368	16.7	1460	20.5	1545	24.4	1634	28.4
16600	1800	999	4.37	1045	5.60	1133	8.18	1222	11.1	1310	14.3	1399	17.8	1489	21.6	1573	25.6	1652	29.8
17700	1919	1060	5.11	1103	6.43	1186	9.15	1269	12.1	1349	15.4	1436	19.0	1517	22.8	1602	26.9		
18800	2039	1121	5.94	1161	7.34	1240	10.2	1317	13.2	1395	16.6	1473	20.3	1553	24.2	1631	28.3		
19900	2158	1182	6.87	1219	8.35	1294	11.4	1367	14.5	1442	18.0	1513	21.7	1590	25.7	1665	29.9		
21000	2277	1243	7.90	1278	9.46	1349	12.6	1420	15.9	1489	19.4	1559	23.2	1627	27.2				
22100	2396	1304	9.03	1338	10.7	1406	14.0	1473	17.4	1537	20.9	1606	24.9						

Shaded values show where Class I fan selections are more efficient than Class II.

Inlet Sound Power, L _{Wi} [dB ref 10 ⁻¹² watts]										
RPM	% WOV	1	2	3	4	5	6	7	8	L _{WiA}
500	100	83	72	68	66	68	61	50	43	71
	80	81	71	65	63	63	58	50	44	67
	60	78	68	63	62	62	59	51	45	66
	50	76	68	63	62	62	59	51	46	66
700	100	75	81	77	74	73	76	59	54	80
	80	68	74	72	70	69	63	56	50	73
	60	69	72	71	67	68	63	57	51	72
	50	70	72	70	67	68	63	57	52	71
950	100	80	91	83	82	81	82	75	63	87
	80	76	90	79	78	77	71	66	59	82
	60	76	85	76	76	76	71	66	61	80
	50	79	84	77	75	75	70	66	62	79
1350	100	84	88	95	92	89	87	88	74	95
	80	79	82	91	87	85	80	76	69	90
	60	81	82	87	84	82	79	75	71	87
	50	84	85	87	83	82	79	75	72	87
1670	100	87	91	99	97	97	92	95	84	102
	80	84	84	93	93	93	87	84	77	96
	60	91	86	92	90	90	85	82	78	94
	50	91	90	92	89	89	85	82	79	93

Outlet Sound Power, L _{Wo} [dB ref 10 ⁻¹² watts]										
RPM	% WOV	1	2	3	4	5	6	7	8	L _{WoA}
500	100	84	75	71	72	69	64	54	45	73
	80	83	72	68	70	66	62	55	44	72
	60	80	70	66	68	66	62	55	44	70
	50	80	71	66	68	65	62	56	45	70
700	100	80	82	80	80	76	75	63	55	82
	80	77	77	76	78	73	68	62	54	79
	60	76	74	73	75	72	67	61	53	76
	50	78	76	73	74	71	67	61	54	76
950	100	86	93	88	88	84	83	76	64	90
	80	82	85	84	85	81	75	68	61	86
	60	83	83	81	82	78	73	67	61	83
	50	84	85	81	81	78	73	67	63	83
1350	100	91	92	97	97	93	90	89	76	98
	80	86	87	92	94	90	85	79	72	95
	60	90	89	90	91	87	82	77	72	92
	50	92	91	91	90	86	82	77	73	91
1670	100	98	96	102	102	99	95	95	85	104
	80	92	91	100	99	97	91	86	79	101
	60	98	94	95	96	94	89	83	79	98
	50	99	97	97	95	92	88	83	79	97

Performance certified is for installation type B: Free inlet, Ducted outlet. Power rating (Bhp) does not include transmission losses. Performance ratings do not include the effects of appurtenances (accessories).

The sound power level ratings shown are in decibels, referred to 10⁻¹² watts, calculated per AMCA Standard 301. Values shown are for inlet L_{Wi}, L_{WiA} and outlet L_{Wo}, L_{WoA} sound power levels for installation type B: Free inlet, Ducted outlet. Ratings for inlet sound do not include the effects of duct end correction. Ratings for outlet sound include the effects of duct end correction. The A-weighted sound power ratings shown have been calculated per AMCA Standard 301. The AMCA Certified Ratings Seal applies to L_{WiA} and L_{WoA} values only.

Performance Data		
Maximum Fan RPM	1234	
Specification Data		
Maximum Motor Frame Size	286T	
Minimum Motor Starting hp	1 1/2 hp	1.1 kW
Wheel Diameter	40.25 in.	1022 mm
Approximate Weight (Less Motor & Drives)	990 lbs.	449 kg.
Maximum Bhp = (Fan RPM / 450) ³		
Outlet Velocity (FPM) = CFM / 11.27		
Tip Speed (FPM) = Fan RPM x 10.5		
% WOV = (CFM x 100) / (Fan RPM x 26.7)		

Imperial data — Metric data

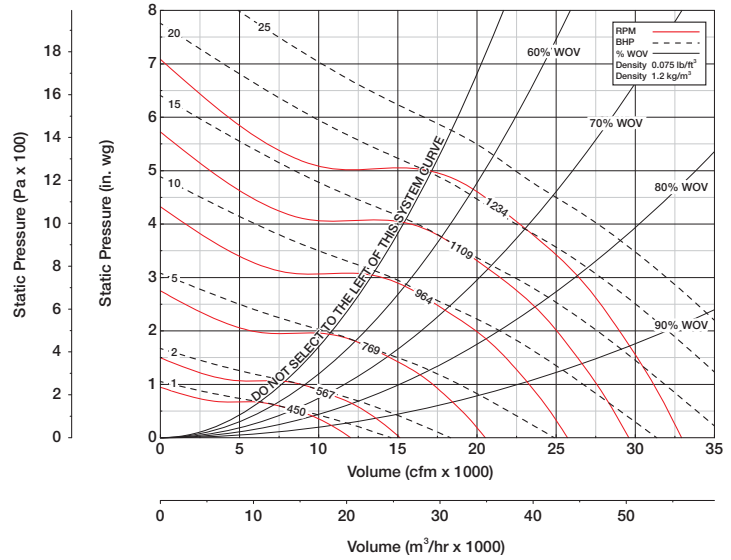

Performance Data

CFM	OV	STATIC PRESSURE (inches wg)																	
		0.25		0.5		1		1.5		2		2.5		3		3.5		4	
		RPM	BHP	RPM	BHP	RPM	BHP	RPM	BHP	RPM	BHP	RPM	BHP	RPM	BHP	RPM	BHP	RPM	BHP
8400	745	379	0.52	444	0.93	562	1.93												
10200	905	435	0.72	489	1.17	593	2.27	687	3.52										
12000	1064	494	0.99	539	1.48	631	2.67	717	4.02	795	5.48								
13800	1224	556	1.35	595	1.88	675	3.13	753	4.60	827	6.17	893	7.81	966	9.68				
15600	1384	618	1.79	653	2.37	723	3.69	793	5.22	862	6.93	927	8.71	988	10.6	1050	12.6	1113	14.7
17400	1543	682	2.32	714	2.96	776	4.37	840	5.97	902	7.74	963	9.66	1022	11.6	1077	13.7	1129	15.8
19200	1703	747	2.97	775	3.67	832	5.17	888	6.83	947	8.67	1003	10.7	1058	12.8	1112	15.0	1163	17.2
21000	1863	812	3.74	837	4.50	889	6.08	940	7.83	994	9.75	1045	11.8	1098	14.0	1149	16.3	1198	18.7
22800	2023	878	4.64	900	5.46	948	7.16	996	8.99	1042	10.9	1093	13.1	1140	15.3	1189	17.8		
24600	2182	944	5.69	965	6.56	1009	8.38	1053	10.3	1097	12.4	1141	14.5	1188	16.9	1231	19.3		
26400	2342	1010	6.89	1029	7.83	1070	9.75	1111	11.8	1153	13.9	1192	16.2						
28200	2502	1076	8.25	1094	9.25	1132	11.3	1171	13.4	1209	15.6								

Inlet Sound Power, L _{Wi} [dB ref 10 ⁻¹² watts]										
RPM	% WOV	1	2	3	4	5	6	7	8	L _{Wi} A
300	100	68	68	62	60	61	48	39	32	64
	80	66	66	60	60	60	49	40	34	62
	60	62	65	59	60	60	49	39	32	62
	50	65	66	60	60	60	49	39	33	62
450	100	74	76	71	70	70	59	50	45	73
	80	71	75	68	70	66	58	51	44	70
	60	69	72	66	70	65	59	52	45	70
	50	69	72	66	70	65	58	52	44	70
600	100	83	81	78	74	73	74	59	54	79
	80	79	80	75	72	72	66	60	53	76
	60	78	79	73	70	71	66	60	54	75
	50	78	79	73	70	71	66	60	54	75
850	100	84	93	88	83	79	84	70	62	88
	80	82	92	85	80	78	74	67	61	84
	60	81	90	80	76	75	73	68	63	81
	50	81	88	80	75	75	73	68	63	81
1234	100	88	98	95	94	90	88	90	75	97
	80	86	96	93	91	88	84	78	72	93
	60	86	95	88	87	84	82	77	73	90
	50	86	95	88	87	84	82	77	73	90

Outlet Sound Power, L _{Wo} [dB ref 10 ⁻¹² watts]										
RPM	% WOV	1	2	3	4	5	6	7	8	L _{Wo} A
300	100	71	67	64	64	64	52	45	38	67
	80	68	68	63	63	63	52	45	38	66
	60	67	68	62	63	63	52	46	39	66
	50	68	69	62	63	64	53	46	40	66
450	100	80	76	73	72	71	62	54	46	74
	80	77	76	70	71	68	61	54	46	72
	60	77	76	68	70	67	60	54	46	71
	50	78	76	69	70	68	60	54	46	72
600	100	88	82	79	80	76	74	61	54	81
	80	86	82	77	78	75	68	61	53	79
	60	85	82	75	75	73	67	61	53	78
	50	84	82	75	75	73	67	61	54	77
850	100	85	90	87	88	83	83	74	65	90
	80	84	90	84	85	80	76	70	62	86
	60	84	88	82	83	78	75	69	64	84
	50	86	89	82	82	78	75	69	64	84
1234	100	91	95	97	99	94	91	91	78	100
	80	89	95	94	96	91	87	82	74	97
	60	92	93	92	93	88	85	80	74	94
	50	94	94	92	93	88	85	80	75	94

Performance certified is for installation type B: Free inlet, Ducted outlet. Power rating (Bhp) does not include transmission losses. Performance ratings do not include the effects of appurtenances (accessories).

The sound power level ratings shown are in decibels, referred to 10⁻¹² watts, calculated per AMCA Standard 301. Values shown are for inlet L_{Wi}, L_{Wi}A and outlet L_{Wo}, L_{Wo}A sound power levels for installation type B: Free inlet, Ducted outlet. Ratings for inlet sound do not include the effects of duct end correction. Ratings for outlet sound include the effects of duct end correction. The A-weighted sound power ratings shown have been calculated per AMCA Standard 301. The AMCA Certified Ratings Seal applies to L_{Wi}A and L_{Wo}A values only.

Performance Data		
Maximum Fan RPM	1522	
Specification Data		
Maximum Motor Frame Size	324T	
Minimum Motor Starting hp	2 hp	1.5 kW
Wheel Diameter	40.25 in.	1022 mm
Approximate Weight (Less Motor & Drives)	1200 lbs.	544 kg.
Maximum Bhp = (Fan RPM / 450) ³		
Outlet Velocity (FPM) = CFM / 11.27		
Tip Speed (FPM) = Fan RPM x 10.5		
% WOV = (CFM x 100) / (Fan RPM x 23.5)		

Imperial data — Metric data

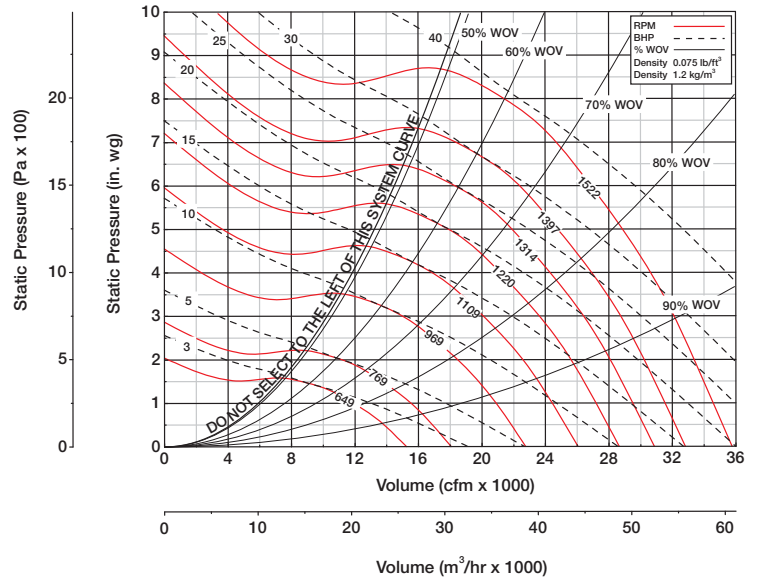

Performance Data

CFM	OV	STATIC PRESSURE (inches wg)																		
		0.5		1		2		3		4		5		6		7		8		
		RPM	BHP	RPM	BHP	RPM	BHP	RPM	BHP	RPM	BHP	RPM	BHP	RPM	BHP	RPM	BHP	RPM	BHP	
12500	1109	599	1.76	668	2.84	797	5.47	923	8.58	1043	11.9									
13900	1233	652	2.17	714	3.32	833	6.06	948	9.29	1059	12.8	1165	16.6							
15300	1357	707	2.64	762	3.87	872	6.71	975	10.0	1080	13.8	1181	17.8	1277	21.9					
16700	1481	762	3.20	812	4.50	915	7.47	1011	10.9	1107	14.8	1200	18.9	1293	23.3	1381	27.8			
18100	1606	818	3.84	862	5.22	958	8.30	1050	11.9	1136	15.8	1227	20.1	1311	24.7	1398	29.4	1480	34.3	
19500	1730	874	4.57	916	6.03	1004	9.26	1092	12.9	1174	17.0	1254	21.4	1338	26.1	1415	31.1	1496	36.1	
20900	1854	931	5.40	971	6.95	1053	10.3	1134	14.1	1212	18.3	1288	22.8	1365	27.6	1442	32.7	1514	38.0	
22300	1978	988	6.34	1026	7.98	1101	11.5	1178	15.4	1253	19.7	1326	24.3	1395	29.2	1469	34.4			
23700	2102	1046	7.38	1081	9.12	1151	12.8	1224	16.8	1296	21.2	1365	25.9	1433	31.0	1496	36.2			
25100	2227	1103	8.55	1137	10.4	1201	14.2	1272	18.4	1340	22.9	1407	27.7	1471	32.9					
26500	2351	1161	9.85	1193	11.8	1254	15.8	1320	20.1	1384	24.7	1450	29.7	1510	34.9					
27900	2475	1219	11.3	1249	13.3	1308	17.5	1370	21.9	1432	26.7	1493	31.7							

Shaded values show where Class I fan selections are more efficient than Class II.

Inlet Sound Power, L _{Wi} [dB ref 10 ⁻¹² watts]										
RPM	% WOV	1	2	3	4	5	6	7	8	L _{Wi} A
450	100	83	74	69	67	71	61	50	44	73
	80	80	72	66	66	67	58	48	40	69
	60	78	70	63	64	66	57	48	40	69
	50	75	69	62	64	66	56	48	40	68
600	100	83	83	77	75	74	78	59	53	81
	80	79	80	73	72	73	65	56	49	76
	60	76	77	70	70	72	64	56	49	75
	50	76	77	70	69	72	63	55	49	74
850	100	79	93	84	85	81	87	73	65	90
	80	75	90	82	82	79	75	67	60	84
	60	74	87	77	79	77	74	67	61	82
	50	79	88	78	77	76	72	65	61	81
1200	100	85	92	97	94	90	89	92	76	98
	80	79	89	94	91	87	83	79	70	93
	60	81	86	91	87	85	81	77	70	90
	50	83	87	89	86	84	81	76	71	89
1522	100	90	94	101	100	96	94	98	86	104
	80	85	89	97	98	94	90	87	79	99
	60	87	88	93	94	90	87	84	78	96
	50	90	91	93	93	90	87	83	79	95

Outlet Sound Power, L _{Wo} [dB ref 10 ⁻¹² watts]										
RPM	% WOV	1	2	3	4	5	6	7	8	L _{Wo} A
450	100	87	77	73	73	74	64	54	47	76
	80	85	77	71	72	72	61	52	45	75
	60	84	76	69	70	72	60	52	45	74
	50	83	77	68	68	72	59	52	45	74
600	100	82	82	79	80	76	66	62	54	82
	80	82	82	77	79	75	68	60	51	80
	60	82	81	75	76	75	67	59	52	78
	50	82	83	74	75	74	65	58	52	77
850	100	85	89	88	90	83	86	75	66	91
	80	82	87	85	88	81	77	70	61	88
	60	82	85	82	84	79	75	68	62	85
	50	85	87	82	83	79	74	67	62	84
1200	100	89	92	95	99	93	90	92	78	100
	80	87	89	93	97	91	87	82	73	97
	60	88	89	90	94	88	84	79	72	94
	50	91	92	92	93	87	83	78	73	93
1522	100	94	96	102	104	99	96	98	87	106
	80	92	93	98	102	97	93	89	81	103
	60	94	95	95	99	94	90	86	79	100
	50	96	97	98	99	94	90	85	80	100

Performance certified is for installation type B: Free inlet, Ducted outlet. Power rating (Bhp) does not include transmission losses. Performance ratings do not include the effects of appurtenances (accessories).

The sound power level ratings shown are in decibels, referred to 10⁻¹² watts, calculated per AMCA Standard 301. Values shown are for inlet L_{Wi}, L_{Wi}A and outlet L_{Wo}, L_{Wo}A sound power levels for installation type B: Free inlet, Ducted outlet. Ratings for inlet sound do not include the effects of duct end correction. Ratings for outlet sound include the effects of duct end correction. The A-weighted sound power ratings shown have been calculated per AMCA Standard 301. The AMCA Certified Ratings Seal applies to L_{Wi}A and L_{Wo}A values only.

Performance Data		
Maximum Fan RPM	1116	
Specification Data		
Maximum Motor Frame Size	286T	
Minimum Motor Starting hp	1½ hp	1.1 kW
Wheel Diameter	44.5 in.	1130 mm
Approximate Weight (Less Motor & Drives)	1200 lbs.	544 kg.
Maximum Bhp = (Fan RPM / 380) ³		
Outlet Velocity (FPM) = CFM / 13.79		
Tip Speed (FPM) = Fan RPM x 11.7		
% WOV = (CFM x 100) / (Fan RPM x 36.1)		

Imperial data — Metric data

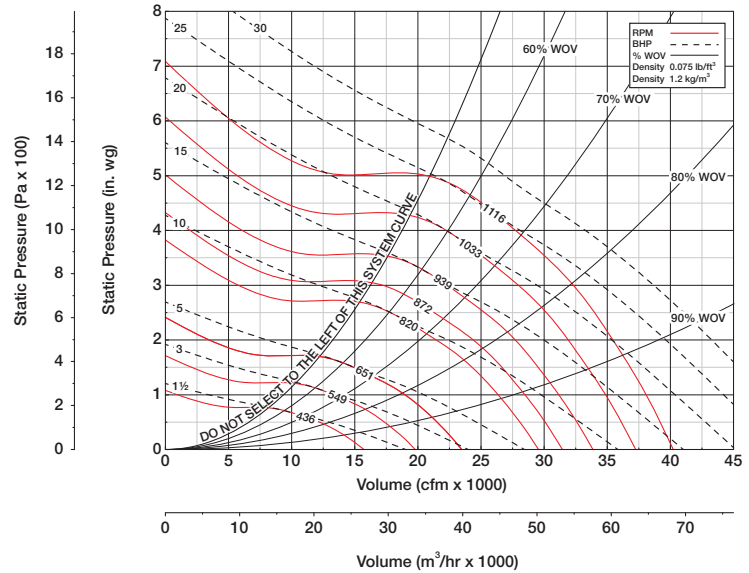

Performance Data

CFM	OV	STATIC PRESSURE (inches wg)																	
		0.25		0.5		1		1.5		2		2.5		3		3.5		4	
		RPM	BHP	RPM	BHP	RPM	BHP	RPM	BHP	RPM	BHP	RPM	BHP	RPM	BHP	RPM	BHP	RPM	BHP
10300	746	343	0.63	402	1.14	508	2.36												
12500	906	394	0.88	443	1.44	537	2.79	622	4.31										
14700	1065	448	1.22	488	1.82	571	3.27	649	4.93	720	6.71								
16900	1225	503	1.65	539	2.31	611	3.83	681	5.63	748	7.55	808	9.57	874	11.8				
19100	1385	560	2.19	592	2.90	654	4.52	718	6.39	780	8.49	839	10.7	894	12.9	950	15.4	1007	18.0
21300	1544	618	2.85	646	3.63	702	5.35	760	7.31	817	9.48	872	11.8	925	14.3	975	16.7	1022	19.3
23500	1704	677	3.64	702	4.50	753	6.33	803	8.36	857	10.6	908	13.1	958	15.7	1006	18.3	1052	21.0
25700	1863	736	4.59	758	5.51	805	7.45	851	9.59	899	11.9	946	14.4	994	17.1	1040	20.0	1084	22.9
27900	2023	795	5.69	815	6.69	859	8.76	902	11.0	943	13.4	989	16.0	1032	18.8	1076	21.7		
30100	2182	854	6.97	873	8.05	913	10.3	953	12.6	993	15.1	1033	17.8	1075	20.7	1114	23.6		
32300	2342	914	8.44	932	9.59	969	12.0	1005	14.4	1043	17.0	1079	19.8						
34500	2501	974	10.1	991	11.3	1024	13.8	1060	16.4	1094	19.1								

Inlet Sound Power, L _{Wi} [dB ref 10 ⁻¹² watts]										
RPM	% WOV	1	2	3	4	5	6	7	8	L _{Wi} A
275	100	70	68	63	62	61	48	39	32	64
	80	68	67	61	61	59	49	40	34	63
	60	64	65	60	61	60	49	39	32	63
	50	66	66	61	61	59	49	39	33	63
400	100	75	76	71	70	69	58	49	45	72
	80	72	74	69	70	65	57	50	43	70
	60	70	72	67	70	65	58	51	44	70
	50	70	71	67	69	65	58	51	43	70
550	100	85	82	79	75	75	73	60	54	79
	80	81	80	76	73	72	66	60	53	76
	60	80	80	74	72	72	66	61	54	76
	50	80	80	74	72	72	66	61	55	75
800	100	87	95	89	84	81	84	71	63	89
	80	85	93	86	81	79	75	68	62	85
	60	84	91	82	77	77	74	69	64	82
	50	84	89	81	77	77	74	69	64	82
1116	100	91	100	96	94	91	89	89	74	97
	80	89	98	94	91	88	84	78	72	93
	60	88	96	89	87	84	82	78	73	90
	50	88	96	89	87	84	82	78	73	90

Outlet Sound Power, L _{Wo} [dB ref 10 ⁻¹² watts]										
RPM	% WOV	1	2	3	4	5	6	7	8	L _{Wo} A
275	100	72	68	65	65	64	53	45	38	67
	80	69	69	64	65	63	53	45	38	66
	60	69	69	63	64	63	53	46	40	66
	50	69	69	63	64	64	53	47	40	66
400	100	80	76	73	72	70	61	53	45	74
	80	78	75	71	71	67	60	53	45	72
	60	77	75	69	70	67	60	53	46	71
	50	78	75	70	70	67	59	53	45	71
550	100	90	83	80	80	77	74	62	54	82
	80	88	82	78	79	75	68	61	53	80
	60	86	82	76	76	74	68	61	53	78
	50	86	82	76	76	74	67	61	54	78
800	100	88	91	89	90	85	84	75	66	91
	80	86	91	86	87	82	77	71	64	87
	60	86	89	84	84	80	76	71	65	85
	50	88	90	84	83	80	76	71	65	85
1116	100	92	97	98	99	95	92	90	77	100
	80	91	96	95	97	92	87	82	74	97
	60	93	94	93	93	89	85	80	74	94
	50	95	95	93	93	89	85	80	75	94

Performance certified is for installation type B: Free inlet, Ducted outlet. Power rating (Bhp) does not include transmission losses. Performance ratings do not include the effects of appurtenances (accessories).

The sound power level ratings shown are in decibels, referred to 10⁻¹² watts, calculated per AMCA Standard 301. Values shown are for inlet L_{Wi}, L_{Wi}A and outlet L_{Wo}, L_{Wo}A sound power levels for installation type B: Free inlet, Ducted outlet. Ratings for inlet sound do not include the effects of duct end correction. Ratings for outlet sound include the effects of duct end correction. The A-weighted sound power ratings shown have been calculated per AMCA Standard 301. The AMCA Certified Ratings Seal applies to L_{Wi}A and L_{Wo}A values only.

Performance Data		
Maximum Fan RPM	1377	
Specification Data		
Maximum Motor Frame Size	326T	
Minimum Motor Starting hp	3 hp	2.2 kW
Wheel Diameter	44.5 in.	1130 mm
Approximate Weight (Less Motor & Drives)	1400 lbs.	635 kg.
Maximum Bhp = (Fan RPM / 381) ³		
Outlet Velocity (FPM) = CFM / 13.79		
Tip Speed (FPM) = Fan RPM x 11.7		
% WOV = (CFM x 100) / (Fan RPM x 31.7)		

Imperial data — Metric data

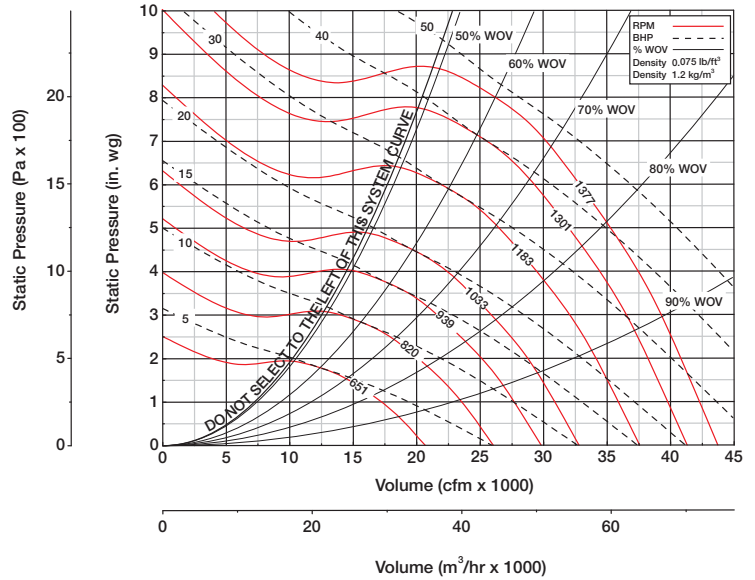

Performance Data

CFM	OV	STATIC PRESSURE (inches wg)																		
		0.5		1		2		3		4		5		6		7		8		
		RPM	BHP	RPM	BHP	RPM	BHP	RPM	BHP	RPM	BHP	RPM	BHP	RPM	BHP	RPM	BHP	RPM	BHP	
15000	1088	534	2.08	598	3.39	716	6.58	832	10.3	941	14.4									
16600	1204	579	2.53	636	3.91	745	7.23	852	11.2	955	15.4	1050	20.0							
18200	1320	625	3.05	677	4.52	778	7.96	875	12.0	970	16.5	1064	21.3	1151	26.3					
19800	1436	671	3.66	718	5.21	814	8.78	902	13.0	993	17.6	1078	22.6	1165	27.8	1244	33.3			
21400	1552	718	4.35	760	5.99	850	9.71	935	14.0	1016	18.8	1099	24.0	1178	29.4	1258	35.1	1332	41.0	
23000	1669	766	5.14	805	6.87	888	10.7	968	15.1	1045	20.1	1122	25.4	1198	31.0	1272	37.0	1346	43.0	
24600	1785	814	6.02	851	7.86	928	11.9	1005	16.4	1077	21.5	1146	26.9	1221	32.7	1291	38.8	1360	45.2	
26200	1901	862	7.02	897	8.96	969	13.8	1041	17.8	1110	22.9	1178	28.5	1244	34.5	1314	40.8			
27800	2017	910	8.13	943	10.2	1010	14.6	1078	19.3	1146	24.6	1210	30.3	1272	36.4	1337	42.8			
29400	2133	959	9.37	990	11.5	1052	16.1	1118	21.0	1182	26.4	1243	32.2	1305	38.4	1362	44.9			
31000	2249	1008	10.7	1038	13.0	1095	17.7	1159	22.9	1219	28.4	1280	34.3	1337	40.6					
32600	2365	1057	12.2	1085	14.6	1140	19.5	1200	24.8	1257	30.4	1316	36.5	1371	42.9					

Shaded values show where Class I fan selections are more efficient than Class II.

		Inlet Sound Power, L _{Wi} [dB ref 10 ⁻¹² watts]									
RPM	% WOV	1	2	3	4	5	6	7	8	L _{Wi} A	
400	100	84	73	69	69	70	60	50	43	73	
	80	81	71	67	66	66	57	47	39	69	
	60	78	69	64	65	65	56	47	39	68	
	50	76	68	63	65	65	55	47	40	67	
550	100	85	84	78	76	76	77	60	54	81	
	80	82	80	74	73	73	65	57	49	76	
	60	78	77	71	71	72	64	56	50	75	
	50	79	78	71	71	72	63	55	50	74	
800	100	82	94	86	86	83	87	74	66	91	
	80	79	92	84	84	80	76	68	61	86	
	60	78	89	79	80	78	75	68	62	83	
	50	82	90	80	79	78	73	67	62	82	
1100	100	87	94	98	95	91	91	91	75	98	
	80	82	91	95	92	88	84	79	71	94	
	60	83	88	91	88	85	82	77	71	91	
	50	85	88	90	87	84	81	77	72	90	
1377	100	92	95	103	101	97	94	100	84	105	
	80	87	90	98	98	94	90	88	79	100	
	60	89	89	94	95	91	88	84	78	96	
	50	92	91	94	94	90	87	84	79	96	

		Outlet Sound Power, L _{Wo} [dB ref 10 ⁻¹² watts]									
RPM	% WOV	1	2	3	4	5	6	7	8	L _{Wo} A	
400	100	87	76	73	74	73	62	53	47	76	
	80	85	77	72	72	71	60	52	44	74	
	60	84	76	69	71	71	59	51	44	73	
	50	84	76	68	70	70	58	51	45	73	
550	100	84	83	80	81	77	76	62	55	83	
	80	84	83	78	80	75	68	60	52	80	
	60	83	82	76	77	75	67	59	52	79	
	50	84	83	75	76	74	66	59	53	78	
800	100	87	91	90	91	85	86	76	67	92	
	80	84	89	87	89	83	78	71	62	89	
	60	84	86	84	86	81	76	69	63	86	
	50	87	89	84	85	80	75	68	63	86	
1100	100	91	94	97	99	94	92	92	77	100	
	80	88	91	94	98	91	87	82	73	98	
	60	90	90	91	94	89	85	79	73	94	
	50	93	93	93	94	88	84	78	73	94	
1377	100	96	97	103	105	99	96	100	86	107	
	80	93	93	100	104	97	93	89	80	104	
	60	96	96	97	100	94	91	86	79	100	
	50	98	98	99	100	94	90	85	80	100	

Performance certified is for installation type B: Free inlet, Ducted outlet. Power rating (Bhp) does not include transmission losses. Performance ratings do not include the effects of appurtenances (accessories).

The sound power level ratings shown are in decibels, referred to 10⁻¹² watts, calculated per AMCA Standard 301. Values shown are for inlet L_{Wi}, L_{Wi}A and outlet L_{Wo}, L_{Wo}A sound power levels for installation type B: Free inlet, Ducted outlet. Ratings for inlet sound do not include the effects of duct end correction. Ratings for outlet sound include the effects of duct end correction. The A-weighted sound power ratings shown have been calculated per AMCA Standard 301. The AMCA Certified Ratings Seal applies to L_{Wi}A and L_{Wo}A values only.

Performance Data		
Maximum Fan RPM	1013	
Specification Data		
Maximum Motor Frame Size	324T	
Minimum Motor Starting hp	5 hp	3.7 kW
Wheel Diameter	49 in.	1245 mm
Approximate Weight (Less Motor & Drives)	1500 lbs.	680 kg.
Maximum Bhp = (Fan RPM / 324) ³		
Outlet Velocity (FPM) = CFM / 16.77		
Tip Speed (FPM) = Fan RPM x 12.8		
% WOV = (CFM x 100) / (Fan RPM x 48.1)		

Imperial data — Metric data

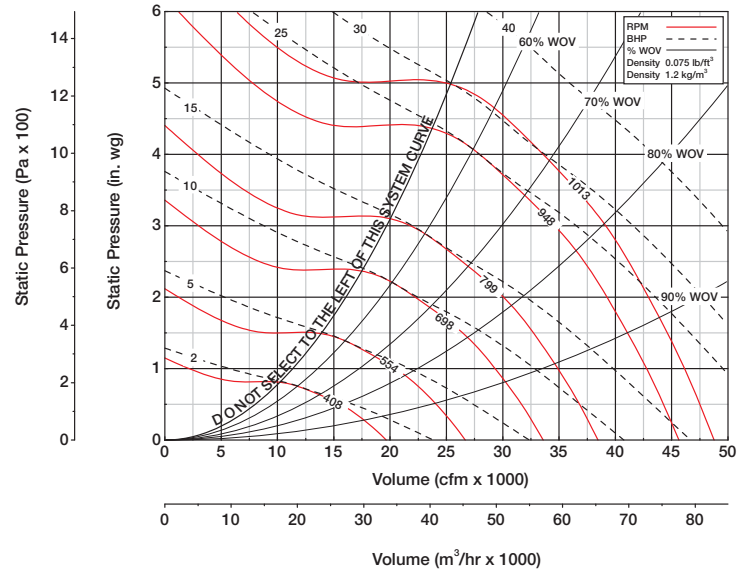

Performance Data

CFM	OV	STATIC PRESSURE (inches wg)																	
		0.25		0.5		1		1.5		2		2.5		3		3.5		4	
		RPM	BHP	RPM	BHP	RPM	BHP	RPM	BHP	RPM	BHP	RPM	BHP	RPM	BHP	RPM	BHP	RPM	BHP
12500	745	312	0.77	365	1.39	462	2.86												
15200	906	359	1.08	403	1.75	488	3.39	565	5.23										
17900	1067	408	1.49	445	2.22	520	3.98	590	6.00	654	8.16								
20600	1228	459	2.03	491	2.82	557	4.68	620	6.86	681	9.20	735	11.7	795	14.4				
23300	1389	511	2.70	540	3.56	596	5.53	654	7.81	710	10.4	764	13.0	813	15.7	863	18.7	915	21.9
26000	1550	565	3.51	590	4.47	641	6.56	693	8.94	744	11.6	794	14.4	842	17.4	887	20.4	930	23.5
28700	1711	619	4.50	641	5.54	687	7.77	733	10.2	781	13.0	827	16.0	872	19.1	916	22.4	958	25.7
31400	1872	673	5.67	693	6.81	735	9.17	777	11.8	820	14.6	864	17.7	906	21.0	947	24.4	986	28.0
34100	2033	727	7.05	746	8.27	785	10.8	824	13.5	861	16.4	903	19.7	941	23.0	981	26.6		
36800	2194	782	8.64	799	9.96	835	12.7	871	15.5	907	18.6	942	21.8	981	25.3				
39500	2355	837	10.5	853	11.9	886	14.8	919	17.7	953	21.0	986	24.3						
42200	2516	892	12.6	907	14.1	937	17.1	969	20.3	1000	23.6								

Inlet Sound Power, L _{Wi} [dB ref 10 ⁻¹² watts]										
RPM	% WOV	1	2	3	4	5	6	7	8	L _{Wi} A
250	100	71	68	64	63	60	48	39	32	64
	80	69	67	62	62	59	49	40	34	63
	60	65	66	61	62	59	48	39	32	63
	50	68	66	62	62	59	48	39	33	63
350	100	76	75	71	70	66	56	49	44	71
	80	73	73	69	69	63	56	49	42	69
	60	71	71	68	69	64	57	50	42	69
	50	71	70	68	69	63	57	50	42	69
500	100	86	82	79	76	76	72	60	54	80
	80	82	81	76	74	72	66	60	53	77
	60	81	80	75	73	72	66	61	54	76
	50	81	80	74	73	72	66	61	55	76
700	100	90	94	88	84	82	82	69	62	88
	80	88	92	85	81	78	74	67	61	84
	60	86	89	81	77	76	73	68	63	82
	50	86	88	80	77	76	73	68	63	81
1013	100	94	101	96	94	91	90	87	72	97
	80	91	99	94	92	88	84	78	72	94
	60	90	97	90	88	85	82	78	73	91
	50	90	97	90	88	85	82	78	73	91

Outlet Sound Power, L _{Wo} [dB ref 10 ⁻¹² watts]										
RPM	% WOV	1	2	3	4	5	6	7	8	L _{Wo} A
250	100	72	69	66	66	63	52	45	38	67
	80	70	69	65	65	62	53	45	38	66
	60	70	69	64	65	63	53	46	40	66
	50	70	69	64	65	63	53	46	40	67
350	100	79	76	73	72	68	60	51	44	73
	80	77	74	71	70	66	59	51	44	71
	60	77	74	69	69	65	59	52	44	70
	50	78	74	70	70	65	58	51	44	71
500	100	90	83	81	81	77	73	61	54	82
	80	88	82	79	79	75	68	61	53	80
	60	87	82	77	77	74	68	61	53	78
	50	86	82	77	76	73	67	61	54	78
700	100	89	91	89	89	85	82	73	65	90
	80	88	90	86	86	81	76	69	62	87
	60	87	88	84	83	79	75	69	64	85
	50	88	89	84	83	79	75	70	64	84
1013	100	94	98	99	99	95	93	89	76	101
	80	92	97	96	97	92	87	81	73	97
	60	94	95	94	93	89	85	80	74	94
	50	95	96	94	93	89	85	80	75	95

Performance certified is for installation type B: Free inlet, Ducted outlet. Power rating (Bhp) does not include transmission losses. Performance ratings do not include the effects of appurtenances (accessories).

The sound power level ratings shown are in decibels, referred to 10⁻¹² watts, calculated per AMCA Standard 301. Values shown are for inlet L_{Wi}, L_{Wi}A and outlet L_{Wo}, L_{Wo}A sound power levels for installation type B: Free inlet, Ducted outlet. Ratings for inlet sound do not include the effects of duct end correction. Ratings for outlet sound include the effects of duct end correction. The A-weighted sound power ratings shown have been calculated per AMCA Standard 301. The AMCA Certified Ratings Seal applies to L_{Wi}A and L_{Wo}A values only.

Performance Data		
Maximum Fan RPM	1251	
Specification Data		
Maximum Motor Frame Size	364T	
Minimum Motor Starting hp	7½ hp	5.5 kW
Wheel Diameter	49 in.	1245 mm
Approximate Weight (Less Motor & Drives)	1900 lbs.	862 kg.
Maximum Bhp = (Fan RPM / 324) ³		
Outlet Velocity (FPM) = CFM / 16.77		
Tip Speed (FPM) = Fan RPM x 12.8		
% WOV = (CFM x 100) / (Fan RPM x 42.4)		

Imperial data — Metric data

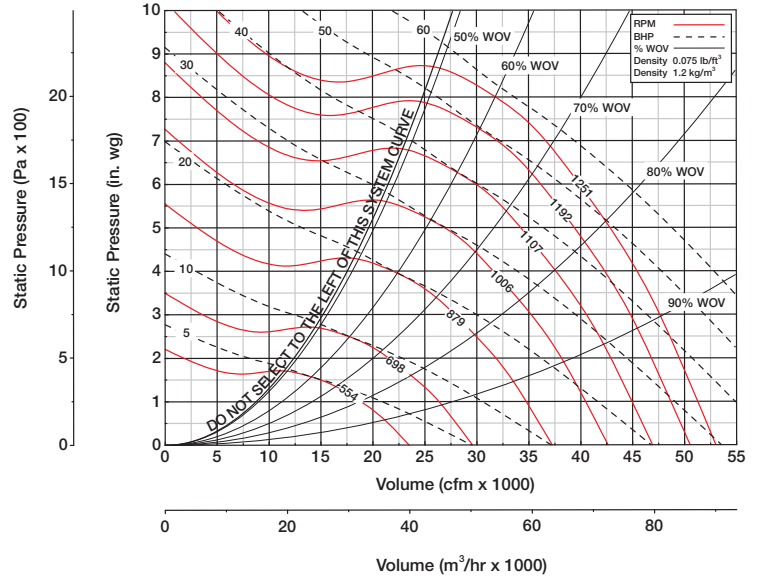

Performance Data

CFM	OV	STATIC PRESSURE (inches wg)																	
		0.5		1		2		3		4		5		6		7		8	
		RPM	BHP	RPM	BHP	RPM	BHP	RPM	BHP	RPM	BHP	RPM	BHP	RPM	BHP	RPM	BHP	RPM	BHP
18000	1077	481	2.48	540	4.06	649	7.91	754	12.4	853	17.3								
20000	1197	523	3.03	575	4.70	675	8.71	772	13.5	866	18.6	953	24.1						
22000	1317	566	3.68	613	5.45	705	9.61	794	14.5	880	20.0	966	25.7	1045	31.8				
24000	1437	609	4.43	652	6.31	739	10.7	819	15.7	902	21.3	979	27.4	1058	33.7	1130	40.4		
26000	1556	653	5.30	691	7.29	773	11.8	849	17.0	923	22.8	999	29.1	1071	35.7	1143	42.6	1210	49.8
28000	1676	698	6.29	733	8.40	808	13.1	881	18.4	950	24.4	1021	30.9	1089	37.8	1156	44.9	1223	52.3
30000	1796	743	7.41	776	9.65	846	14.6	915	20.1	981	26.2	1043	32.7	1111	39.8	1174	47.3	1236	55.0
32000	1916	788	8.67	820	11.0	884	16.2	949	21.8	1011	28.1	1073	34.9	1132	42.0	1195	49.7		
34000	2035	833	10.1	863	12.6	923	17.9	984	23.7	1046	30.2	1104	37.1	1160	44.5	1217	52.2		
36000	2155	879	11.7	907	14.3	963	19.8	1022	25.9	1080	32.5	1135	39.5	1190	47.1	1242	55.0		
38000	2275	925	13.4	951	16.2	1003	21.9	1060	28.2	1114	34.9	1169	42.2	1221	49.8				
40000	2395	971	15.3	996	18.2	1046	24.2	1099	30.7	1150	37.6	1203	45.0						

Shaded values show where Class I fan selections are more efficient than Class II.

Inlet Sound Power, L _{wi} [dB ref 10 ⁻¹² watts]										
RPM	% WOV	1	2	3	4	5	6	7	8	L _{wi} A
350	100	82	73	69	69	68	58	49	42	72
	80	79	70	67	67	64	55	46	38	68
	60	77	68	64	66	63	54	46	38	67
	50	75	67	63	65	63	54	46	38	66
500	100	87	84	78	77	77	75	60	54	81
	80	83	80	75	74	73	65	56	49	76
	60	80	77	72	73	72	64	56	50	75
	50	81	77	72	72	72	63	55	50	75
700	100	85	93	86	85	84	85	73	64	90
	80	82	90	84	83	80	75	67	60	85
	60	80	87	80	80	78	74	67	61	82
	50	84	88	80	79	77	72	66	62	82
1000	100	89	96	98	95	92	92	90	74	99
	80	85	93	95	92	88	84	79	70	94
	60	85	90	92	89	86	82	77	71	91
	50	87	89	90	88	85	81	77	72	90
1251	100	93	97	104	101	97	96	99	83	105
	80	89	92	99	99	94	90	87	78	100
	60	90	91	95	95	91	88	84	78	97
	50	93	93	95	94	90	88	84	79	96

Outlet Sound Power, L _{wo} [dB ref 10 ⁻¹² watts]										
RPM	% WOV	1	2	3	4	5	6	7	8	L _{wo} A
350	100	85	76	73	74	71	61	52	46	75
	80	83	75	72	72	68	58	50	42	73
	60	83	74	70	71	68	57	50	43	72
	50	82	74	68	70	68	57	50	43	72
500	100	85	84	81	81	78	75	62	54	83
	80	85	83	80	80	75	68	60	51	81
	60	85	82	77	78	75	67	59	52	79
	50	85	82	76	77	74	66	59	53	78
700	100	88	91	90	90	86	84	74	65	92
	80	85	89	87	88	82	77	69	61	88
	60	85	86	84	85	80	75	68	62	85
	50	87	88	84	84	79	74	67	62	85
1000	100	92	95	98	99	94	93	91	76	101
	80	89	92	96	98	92	88	81	73	98
	60	91	91	93	94	89	85	79	73	95
	50	94	93	94	94	88	84	78	74	94
1251	100	97	99	104	105	100	97	99	85	107
	80	94	95	101	104	97	94	89	80	104
	60	97	97	98	100	94	91	86	79	101
	50	99	99	100	100	94	90	85	80	100

Performance certified is for installation type B: Free inlet, Ducted outlet. Power rating (Bhp) does not include transmission losses. Performance ratings do not include the effects of appurtenances (accessories).

The sound power level ratings shown are in decibels, referred to 10⁻¹² watts, calculated per AMCA Standard 301. Values shown are for inlet L_{wi}, L_{wi}A and outlet L_{wo}, L_{wo}A sound power levels for installation type B: Free inlet, Ducted outlet. Ratings for inlet sound do not include the effects of duct end correction. Ratings for outlet sound include the effects of duct end correction. The A-weighted sound power ratings shown have been calculated per AMCA Standard 301. The AMCA Certified Ratings Seal applies to L_{wi}A and L_{wo}A values only.

Performance Data		
Maximum Fan RPM	915	
Specification Data		
Maximum Motor Frame Size	326T	
Minimum Motor Starting hp	7½ hp	5.5 kW
Wheel Diameter	54.25 in.	1378 mm
Approximate Weight (Less Motor & Drives)	2000 lbs.	907 kg.
Maximum Bhp = (Fan RPM / 273) ³		
Outlet Velocity (FPM) = CFM / 20.49		
Tip Speed (FPM) = Fan RPM x 14.2		
% WOV = (CFM x 100) / (Fan RPM x 65.3)		

Imperial data — Metric data

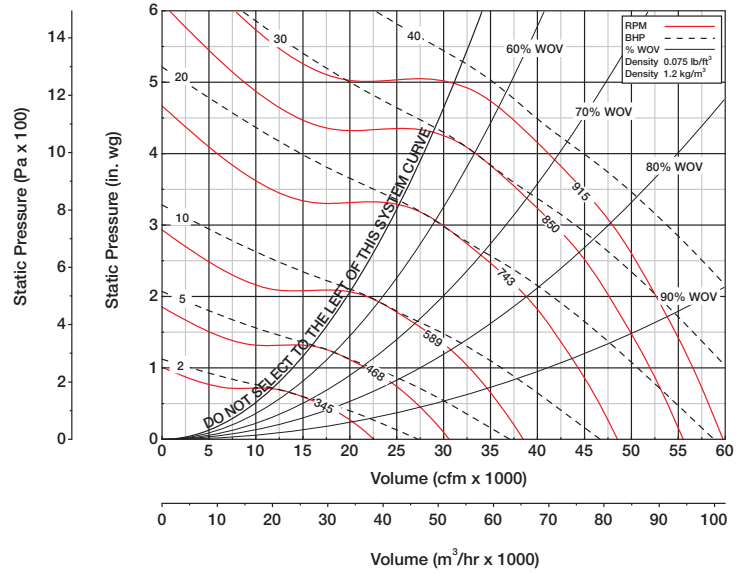

Performance Data

CFM	OV	STATIC PRESSURE (inches wg)																	
		0.25		0.5		1		1.5		2		2.5		3		3.5		4	
		RPM	BHP	RPM	BHP	RPM	BHP	RPM	BHP	RPM	BHP	RPM	BHP	RPM	BHP	RPM	BHP	RPM	BHP
15200	741	280	0.93	329	1.69	417	3.49												
18500	902	322	1.30	362	2.12	440	4.12	510	6.39										
21800	1063	367	1.81	400	2.69	468	4.84	532	7.31	590	9.96								
25100	1224	413	2.45	442	3.42	501	5.70	559	8.36	613	11.2	663	14.2	717	17.6				
28400	1386	459	3.26	485	4.32	537	6.72	589	9.51	640	12.6	689	15.9	733	19.2	779	22.8	826	26.8
31700	1547	507	4.25	531	5.42	577	7.97	624	10.9	670	14.1	715	17.6	759	21.2	800	24.9	838	28.7
35000	1708	556	5.44	577	6.72	619	9.44	660	12.5	704	15.8	745	19.5	786	23.3	826	27.3	864	31.3
38300	1869	605	6.86	623	8.25	661	11.1	700	14.3	739	17.8	777	21.5	816	25.6	853	29.8	889	34.1
41600	2030	654	8.53	670	10.0	706	13.1	741	16.5	775	20.0	813	23.9	847	28.0	884	32.4		
44900	2191	703	10.5	719	12.1	751	15.4	784	18.9	816	22.6	849	26.6	883	30.9				
48200	2352	753	12.7	767	14.4	797	17.9	827	21.6	858	25.5	888	29.6						
51500	2513	802	15.2	816	17.0	843	20.8	872	24.6	901	28.7								

Inlet Sound Power, L _{Wi} [dB ref 10 ⁻¹² watts]										
RPM	% WOV	1	2	3	4	5	6	7	8	L _{WiA}
225	100	71	68	64	64	59	47	39	32	64
	80	70	67	63	63	58	48	40	34	63
	60	66	65	62	63	58	48	39	32	63
	50	68	66	63	63	58	47	39	33	63
325	100	77	76	72	72	67	56	50	45	72
	80	75	74	71	70	64	57	49	42	70
	60	73	72	70	70	64	58	51	43	70
	50	73	71	70	70	64	57	50	42	70
450	100	86	83	79	77	76	71	60	54	80
	80	83	81	77	75	72	66	60	53	77
	60	82	80	75	74	72	66	60	54	76
	50	82	79	75	74	72	66	61	54	76
650	100	92	95	89	85	84	82	70	63	89
	80	91	93	86	82	79	74	68	62	85
	60	89	90	82	79	78	74	69	64	83
	50	88	88	81	79	78	74	69	64	82
915	100	96	101	97	95	92	91	86	71	98
	80	94	99	95	92	88	84	78	71	94
	60	93	96	90	88	86	82	78	74	91
	50	93	96	90	88	86	82	78	74	91

Outlet Sound Power, L _{Wo} [dB ref 10 ⁻¹² watts]										
RPM	% WOV	1	2	3	4	5	6	7	8	L _{WoA}
225	100	72	69	67	67	62	52	45	38	67
	80	71	69	66	66	62	52	45	38	67
	60	71	68	65	66	62	53	46	39	66
	50	71	69	65	66	62	53	46	40	67
325	100	80	77	74	74	69	60	52	45	74
	80	79	75	73	71	66	59	52	44	72
	60	78	74	71	71	66	59	52	45	71
	50	79	75	71	71	66	59	52	45	72
450	100	90	84	82	81	78	72	61	53	82
	80	88	83	80	80	75	68	60	52	80
	60	87	82	78	77	74	68	61	53	79
	50	87	82	77	77	73	67	61	54	78
650	100	91	92	91	90	86	83	74	65	91
	80	90	91	88	87	82	77	70	63	88
	60	89	89	86	84	80	76	70	65	86
	50	90	90	85	84	80	76	71	65	86
915	100	95	99	100	100	95	93	88	75	101
	80	94	98	97	97	92	88	81	73	98
	60	95	96	95	93	89	85	80	74	95
	50	96	97	95	93	89	85	80	75	95

Performance certified is for installation type B: Free inlet, Ducted outlet. Power rating (Bhp) does not include transmission losses. Performance ratings do not include the effects of appurtenances (accessories).

The sound power level ratings shown are in decibels, referred to 10⁻¹² watts, calculated per AMCA Standard 301. Values shown are for inlet L_{Wi}, L_{WiA} and outlet L_{Wo}, L_{WoA} sound power levels for installation type B: Free inlet, Ducted outlet. Ratings for inlet sound do not include the effects of duct end correction. Ratings for outlet sound include the effects of duct end correction. The A-weighted sound power ratings shown have been calculated per AMCA Standard 301. The AMCA Certified Ratings Seal applies to L_{WiA} and L_{WoA} values only.

Performance Data		
Maximum Fan RPM	1129	
Specification Data		
Maximum Motor Frame Size	365T	
Minimum Motor Starting hp	10 hp	7.5 kW
Wheel Diameter	54.25 in.	1378 mm
Approximate Weight (Less Motor & Drives)	2300 lbs.	1043 kg.
Maximum Bhp = (Fan RPM / 274) ³		
Outlet Velocity (FPM) = CFM / 20.49		
Tip Speed (FPM) = Fan RPM x 14.2		
% WOV = (CFM x 100) / (Fan RPM x 57.5)		

Imperial data — Metric data

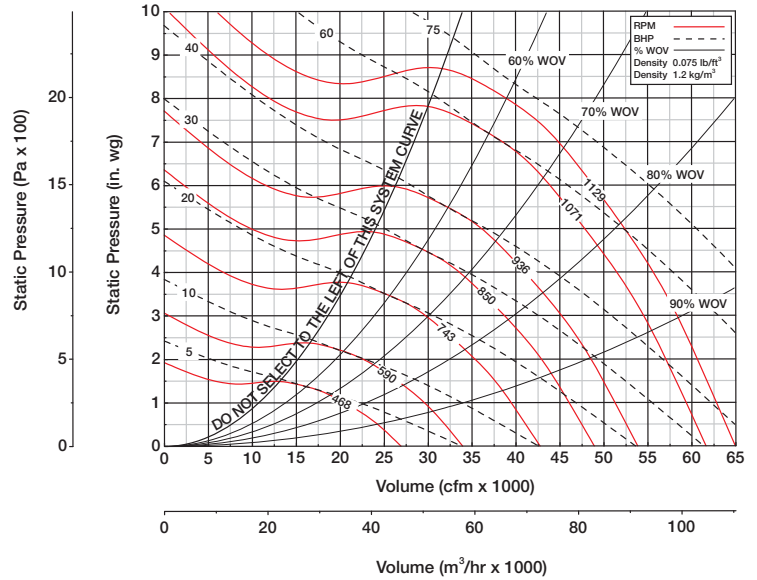

Performance Data

CFM	OV	STATIC PRESSURE (inches wg)																	
		0.5		1		2		3		4		5		6		7		8	
		RPM	BHP	RPM	BHP	RPM	BHP	RPM	BHP	RPM	BHP	RPM	BHP	RPM	BHP	RPM	BHP	RPM	BHP
22000	1074	434	3.02	487	4.95	585	9.67	681	15.2	770	21.2								
24500	1196	472	3.71	519	5.75	609	10.7	698	16.5	782	22.8	861	29.6						
27000	1319	512	4.52	554	6.70	637	11.8	717	17.8	795	24.5	873	31.6	944	39.0				
29500	1441	552	5.46	590	7.78	668	13.1	741	19.3	815	26.2	885	33.7	956	41.4	1021	49.6		
32000	1563	592	6.55	626	9.00	700	14.5	769	20.9	835	28.0	903	35.8	968	44.0	1033	52.4	1094	61.1
34500	1685	633	7.80	665	10.4	732	16.2	798	22.8	860	30.1	923	38.0	985	46.5	1045	55.3	1106	64.4
37000	1807	675	9.21	705	12.0	767	18.0	829	24.8	888	32.3	945	40.4	1005	49.1	1062	58.2	1118	67.7
39500	1929	716	10.8	745	13.7	803	20.0	861	27.0	917	34.7	972	43.0	1025	51.8	1082	61.3		
42000	2051	758	12.6	785	15.7	839	22.3	894	29.4	949	37.4	1000	45.8	1051	54.9	1102	64.4		
44500	2173	800	14.6	825	17.8	875	24.7	928	32.2	980	40.2	1029	48.9	1079	58.2	1126	67.9		
47000	2296	842	16.8	866	20.2	913	27.4	963	35.1	1012	43.3	1061	52.3	1107	61.7				
49500	2418	885	19.2	907	22.8	952	30.3	999	38.3	1046	46.7	1093	55.8						

Shaded values show where Class I fan selections are more efficient than Class II.

Inlet Sound Power, L _{Wi} [dB ref 10 ⁻¹² watts]										
RPM	% WOV	1	2	3	4	5	6	7	8	L _{Wi} A
325	100	82	74	70	71	69	58	49	43	73
	80	79	71	68	68	64	55	46	38	69
	60	77	69	66	67	64	55	46	38	68
	50	75	68	65	67	63	54	46	39	67
450	100	89	83	79	78	78	73	60	53	82
	80	85	80	75	75	72	64	56	49	77
	60	82	77	73	74	72	64	56	50	75
	50	82	77	72	73	71	62	55	50	75
650	100	88	93	88	86	86	85	73	65	91
	80	85	91	85	84	81	75	68	61	86
	60	83	87	81	81	79	74	68	62	83
	50	86	88	81	80	78	73	67	63	83
900	100	91	98	99	95	92	94	88	72	99
	80	87	95	96	92	88	84	78	70	94
	60	86	91	92	89	86	82	77	71	91
	50	88	90	91	88	85	82	77	72	91
1129	100	95	99	104	102	98	97	97	82	105
	80	90	95	100	99	95	91	87	78	100
	60	91	92	96	95	92	88	84	78	97
	50	94	94	96	95	91	88	84	80	97

Outlet Sound Power, L _{Wo} [dB ref 10 ⁻¹² watts]										
RPM	% WOV	1	2	3	4	5	6	7	8	L _{Wo} A
325	100	85	77	75	75	71	61	53	46	76
	80	84	76	73	74	69	59	51	43	74
	60	83	75	71	73	68	58	51	44	73
	50	83	75	70	72	68	58	51	44	73
450	100	87	84	82	81	79	73	62	54	83
	80	86	83	81	80	75	67	59	51	81
	60	86	81	78	79	74	66	59	52	79
	50	86	82	77	77	73	65	59	52	78
650	100	90	92	92	91	87	85	75	66	93
	80	87	90	89	89	83	78	70	61	89
	60	86	87	86	86	81	76	69	62	86
	50	89	89	86	85	80	74	68	63	86
900	100	93	96	100	99	95	94	89	75	101
	80	90	93	98	97	92	88	81	72	98
	60	92	91	94	94	89	85	79	73	95
	50	94	93	95	94	89	84	79	74	95
1129	100	98	101	105	105	100	99	98	84	107
	80	95	97	103	104	98	94	88	80	104
	60	98	98	100	100	95	91	86	79	101
	50	99	100	101	100	94	90	85	80	101

Performance certified is for installation type B: Free inlet, Ducted outlet. Power rating (Bhp) does not include transmission losses. Performance ratings do not include the effects of appurtenances (accessories).

The sound power level ratings shown are in decibels, referred to 10⁻¹² watts, calculated per AMCA Standard 301. Values shown are for inlet L_{Wi}, L_{Wi}A and outlet L_{Wo}, L_{Wo}A sound power levels for installation type B: Free inlet, Ducted outlet. Ratings for inlet sound do not include the effects of duct end correction. Ratings for outlet sound include the effects of duct end correction. The A-weighted sound power ratings shown have been calculated per AMCA Standard 301. The AMCA Certified Ratings Seal applies to L_{Wi}A and L_{Wo}A values only.

Performance Data		
Maximum Fan RPM	828	
Specification Data		
Maximum Motor Frame Size	364T	
Minimum Motor Starting hp	10 hp	7.5 kW
Wheel Diameter	60 in.	1524 mm
Approximate Weight (Less Motor & Drives)	2400 lbs.	1089 kg.
Maximum Bhp = (Fan RPM / 231) ³		
Outlet Velocity (FPM) = CFM / 24.85		
Tip Speed (FPM) = Fan RPM x 15.7		
% WOV = (CFM x 100) / (Fan RPM x 88.4)		

Imperial data — Metric data

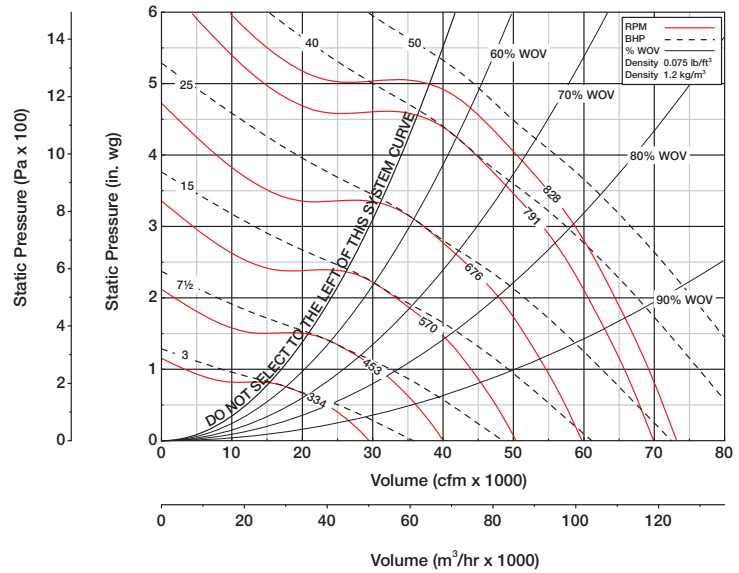

Performance Data

CFM	OV	STATIC PRESSURE (inches wg)																	
		0.25		0.5		1		1.5		2		2.5		3		3.5		4	
		RPM	BHP	RPM	BHP	RPM	BHP	RPM	BHP	RPM	BHP	RPM	BHP	RPM	BHP	RPM	BHP	RPM	BHP
18000	724	248	1.08	293	2.00	375	4.18												
22000	885	285	1.52	323	2.51	394	4.91	459	7.67										
26000	1046	325	2.10	356	3.16	418	5.77	477	8.73	532	12.0								
30000	1207	366	2.85	393	4.02	448	6.77	500	10.0	551	13.4	597	17.1	647	21.2				
34000	1368	407	3.79	432	5.06	479	7.98	527	11.4	574	15.1	618	19.0	659	23.1	703	27.6		
38000	1529	450	4.95	472	6.35	514	9.43	558	13.0	601	16.9	641	21.1	682	25.5	719	29.9	755	34.6
42000	1690	494	6.34	513	7.88	552	11.2	590	14.8	629	18.9	668	23.3	705	28.0	742	32.8	776	37.7
46000	1851	538	8.01	554	9.67	590	13.2	625	17.0	661	21.3	696	25.8	732	30.7	766	35.8	799	41.0
50000	2012	582	9.96	597	11.8	630	15.5	662	19.5	694	23.9	728	28.6	759	33.6	793	38.9	824	44.4
54000	2173	626	12.2	640	14.2	670	18.1	700	22.4	730	26.9	760	31.7	792	36.9	820	42.3		
58000	2334	670	14.8	683	16.9	711	21.1	739	25.5	767	30.3	794	35.2	823	40.6				
62000	2494	714	17.8	727	20.0	752	24.5	779	29.2	805	34.1								

Inlet Sound Power, L _{Wi} [dB ref 10 ⁻¹² watts]										
RPM	% WOV	1	2	3	4	5	6	7	8	L _{WiA}
200	100	72	68	64	64	57	46	38	31	64
	80	70	66	63	63	57	47	40	34	63
	60	67	65	63	63	57	47	38	31	63
	50	69	66	63	63	56	46	39	33	63
300	100	79	76	73	73	67	57	50	46	73
	80	77	74	73	71	65	57	50	43	71
	60	75	72	72	71	65	58	51	44	71
	50	74	72	71	70	65	58	51	43	71
425	100	88	84	81	79	78	71	61	55	82
	80	85	82	78	77	74	67	61	54	78
	60	84	81	76	76	73	68	62	55	78
	50	84	81	76	76	73	68	62	56	78
575	100	94	94	89	84	85	80	69	62	89
	80	93	92	86	82	79	74	67	61	85
	60	91	88	81	79	78	74	68	63	82
	50	90	87	81	79	77	73	68	64	82
828	100	98	101	98	95	92	93	85	70	99
	80	96	99	96	93	89	84	78	71	94
	60	95	96	91	89	86	83	78	74	91
	50	95	96	91	89	86	83	78	74	91

Outlet Sound Power, L _{Wo} [dB ref 10 ⁻¹² watts]										
RPM	% WOV	1	2	3	4	5	6	7	8	L _{WoA}
200	100	72	69	67	67	60	51	44	37	67
	80	72	69	67	67	60	52	44	37	67
	60	71	68	66	67	60	52	45	39	66
	50	71	68	66	67	61	52	46	39	67
300	100	81	78	76	75	69	61	53	45	75
	80	80	76	74	72	67	60	52	45	73
	60	79	75	72	72	67	60	53	45	72
	50	80	75	73	72	67	60	53	45	73
425	100	91	85	84	82	80	73	62	55	84
	80	89	84	82	81	76	69	61	53	82
	60	89	83	80	79	75	69	62	54	80
	50	88	83	79	79	75	69	62	55	80
575	100	92	92	91	89	87	81	73	64	91
	80	92	90	88	86	82	76	69	62	87
	60	90	88	86	84	80	76	70	64	86
	50	91	89	86	83	80	75	70	65	85
828	100	97	100	102	100	96	94	87	74	102
	80	96	98	99	97	92	88	81	73	98
	60	96	96	96	94	90	86	80	74	95
	50	97	97	96	94	90	85	81	75	95

Performance certified is for installation type B: Free inlet, Ducted outlet. Power rating (Bhp) does not include transmission losses. Performance ratings do not include the effects of appurtenances (accessories).

The sound power level ratings shown are in decibels, referred to 10⁻¹² watts, calculated per AMCA Standard 301. Values shown are for inlet L_{Wi}, L_{WiA} and outlet L_{Wo}, L_{WoA} sound power levels for installation type B: Free inlet, Ducted outlet. Ratings for inlet sound do not include the effects of duct end correction. Ratings for outlet sound include the effects of duct end correction. The A-weighted sound power ratings shown have been calculated per AMCA Standard 301. The AMCA Certified Ratings Seal applies to L_{WiA} and L_{WoA} values only.

Performance Data		
Maximum Fan RPM	1020	
Specification Data		
Maximum Motor Frame Size	405T	
Minimum Motor Starting hp	15 hp	11 kW
Wheel Diameter	60 in.	1524 mm
Approximate Weight (Less Motor & Drives)	3100 lbs.	1406 kg.
Maximum Bhp = (Fan RPM / 231) ³		
Outlet Velocity (FPM) = CFM / 24.85		
Tip Speed (FPM) = Fan RPM x 15.7		
% WOV = (CFM x 100) / (Fan RPM x 77.8)		

Imperial data — Metric data

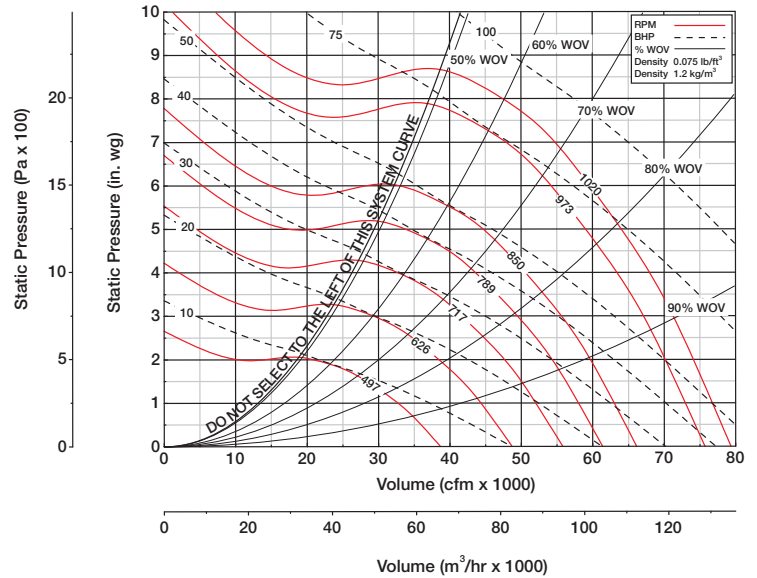

Performance Data

CFM	OV	STATIC PRESSURE (inches wg)																	
		0.5		1		2		3		4		5		6		7		8	
		RPM	BHP	RPM	BHP	RPM	BHP	RPM	BHP	RPM	BHP	RPM	BHP	RPM	BHP	RPM	BHP	RPM	BHP
27000	1078	393	3.72	441	6.09	530	11.9	616	18.7	697	26.0								
30000	1198	427	4.55	470	7.05	551	13.1	631	20.2	707	28.0	778	36.2						
33000	1317	462	5.52	501	8.18	576	14.4	648	21.8	719	30.0	789	38.6	853	47.7				
36000	1437	498	6.65	533	9.48	604	16.0	669	23.5	736	32.0	800	41.1	864	50.6	923	60.5		
39000	1557	534	7.95	565	10.9	631	17.7	694	25.5	754	34.2	816	43.6	874	53.6	933	63.9	988	74.6
42000	1677	570	9.43	599	12.6	660	19.6	719	27.7	776	36.6	834	46.3	890	56.6	944	67.4	999	78.5
45000	1797	607	11.1	634	14.5	691	21.8	748	30.1	801	39.2	852	49.1	907	59.7	959	70.9	1010	82.5
48000	1916	644	13.0	670	16.6	722	24.2	775	32.7	826	42.1	876	52.3	925	63.0	976	74.5		
51000	2036	681	15.1	705	18.9	754	26.9	804	35.6	854	45.3	901	55.6	947	66.7	994	78.3		
54000	2156	718	17.5	741	21.4	786	29.8	835	38.8	882	48.7	927	59.2	972	70.6	1014	82.4		
57000	2276	755	20.1	777	24.2	820	32.9	866	42.3	910	52.3	955	63.2	997	74.7				
60000	2396	793	23.0	814	27.3	854	36.4	898	46.1	940	56.4	983	67.5						

Shaded values show where Class I fan selections are more efficient than Class II.

Inlet Sound Power, L _{Wi} [dB ref 10 ⁻¹² watts]										
RPM	% WOV	1	2	3	4	5	6	7	8	L _{WiA}
300	100	82	75	72	73	69	58	50	44	73
	80	79	72	69	70	65	56	47	39	70
	60	77	69	67	69	64	55	47	39	69
	50	76	68	66	68	63	55	47	39	68
425	100	91	85	81	79	81	73	61	55	83
	80	87	81	77	77	74	65	57	50	78
	60	84	78	75	76	73	65	57	51	77
	50	84	78	74	75	72	63	57	51	76
575	100	91	92	88	86	88	83	72	64	91
	80	88	89	86	84	80	74	67	60	86
	60	86	86	82	81	79	74	67	61	83
	50	88	87	81	80	77	72	66	62	82
825	100	93	100	99	96	93	95	87	71	100
	80	89	97	97	93	89	85	78	70	95
	60	88	93	93	90	87	83	77	71	92
	50	90	92	92	89	86	82	78	73	91
1020	100	96	102	105	102	98	99	96	80	105
	80	91	97	101	99	95	91	86	77	101
	60	92	94	97	96	92	89	84	78	97
	50	94	95	97	95	91	88	84	80	97

Outlet Sound Power, L _{Wo} [dB ref 10 ⁻¹² watts]										
RPM	% WOV	1	2	3	4	5	6	7	8	L _{WoA}
300	100	85	78	76	77	71	61	53	47	77
	80	84	77	75	75	69	59	51	44	75
	60	83	75	73	75	68	59	51	44	74
	50	83	75	71	74	68	58	51	45	74
425	100	89	85	84	83	81	74	63	55	85
	80	88	84	83	82	76	69	60	52	82
	60	88	83	80	80	75	68	60	53	81
	50	88	83	79	79	74	67	60	54	80
575	100	91	93	93	90	88	83	74	64	93
	80	89	90	90	88	83	77	69	60	89
	60	87	87	87	85	81	75	68	62	86
	50	90	88	86	84	80	74	68	63	86
825	100	95	98	101	99	95	96	89	74	102
	80	92	95	99	98	93	88	81	72	99
	60	93	92	96	95	90	85	79	73	96
	50	96	94	97	94	89	84	79	74	95
1020	100	99	103	106	105	101	100	97	83	107
	80	96	99	104	104	98	94	88	79	104
	60	98	99	101	100	95	91	86	79	101
	50	100	101	102	100	95	90	85	80	101

Performance certified is for installation type B: Free inlet, Ducted outlet. Power rating (Bhp) does not include transmission losses. Performance ratings do not include the effects of appurtenances (accessories).

The sound power level ratings shown are in decibels, referred to 10⁻¹² watts, calculated per AMCA Standard 301. Values shown are for inlet L_{Wi}, L_{WiA} and outlet L_{Wo}, L_{WoA} sound power levels for installation type B: Free inlet, Ducted outlet. Ratings for inlet sound do not include the effects of duct end correction. Ratings for outlet sound include the effects of duct end correction. The A-weighted sound power ratings shown have been calculated per AMCA Standard 301. The AMCA Certified Ratings Seal applies to L_{WiA} and L_{WoA} values only.

Performance Data		
Maximum Fan RPM	752	
Specification Data		
Maximum Motor Frame Size	365T	
Minimum Motor Starting hp	10 hp	7.5 kW
Wheel Diameter	66 in.	1676 mm
Approximate Weight (Less Motor & Drives)	2900 lbs.	1315 kg.
Maximum Bhp = (Fan RPM / 197) ³		
Outlet Velocity (FPM) = CFM / 30.46		
Tip Speed (FPM) = Fan RPM x 17.3		
% WOV = (CFM x 100) / (Fan RPM x 118)		

Imperial data — Metric data

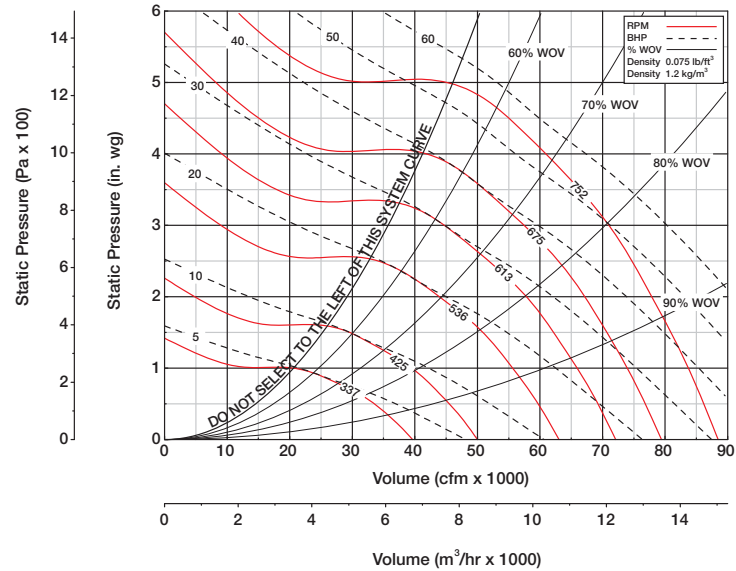

Performance Data

CFM	OV	STATIC PRESSURE (inches wg)																	
		0.25		0.5		1		1.5		2		2.5		3		3.5		4	
		RPM	BHP	RPM	BHP	RPM	BHP	RPM	BHP	RPM	BHP	RPM	BHP	RPM	BHP	RPM	BHP	RPM	BHP
23000	755	234	1.43	272	2.56	343	5.24												
27800	912	268	1.99	300	3.21	363	6.20	420	9.54										
32600	1070	304	2.73	331	4.05	386	7.25	439	10.9	486	14.8	536	19.4						
37400	1227	341	3.68	365	5.13	414	8.50	460	12.5	505	16.7	546	21.2	590	26.2				
42200	1385	379	4.87	400	6.44	442	10.0	485	14.1	527	18.8	567	23.6	603	28.5	641	33.9	679	39.7
47000	1543	418	6.32	437	8.05	475	11.8	514	16.2	551	20.9	588	26.1	624	31.5	658	36.9	689	42.6
51800	1700	457	8.06	474	9.94	508	14.0	542	18.4	578	23.4	612	28.8	646	34.5	679	40.4	710	46.4
56600	1858	497	10.1	511	12.2	543	16.4	574	21.1	607	26.3	638	31.8	670	37.8	701	44.0	730	50.4
61400	2015	536	12.5	550	14.7	579	19.3	608	24.2	636	29.5	667	35.3	695	41.3	725	47.8		
66200	2173	576	15.3	589	17.7	616	22.6	643	27.7	669	33.2	696	39.1	725	45.4	751	52.0		
71000	2330	616	18.5	628	21.1	653	26.2	678	31.6	703	37.4	727	43.4						
75800	2488	656	22.2	667	24.9	690	30.4	714	36.0	737	42.0								

Inlet Sound Power, L _{Wi} [dB ref 10 ⁻¹² watts]										
RPM	% WOV	1	2	3	4	5	6	7	8	L _{Wi} A
200	100	75	71	67	67	60	49	41	34	67
	80	73	69	66	66	60	50	43	37	66
	60	71	68	66	66	60	49	41	34	66
	50	72	69	66	66	59	49	42	36	66
275	100	80	77	74	74	66	57	51	47	74
	80	78	74	74	71	65	57	50	43	72
	60	76	72	73	71	65	58	51	44	71
	50	76	72	73	71	65	58	51	43	71
375	100	87	84	80	79	79	69	60	55	81
	80	85	82	78	77	73	66	60	53	78
	60	84	80	76	76	73	67	61	54	77
	50	84	80	76	76	72	67	61	55	77
525	100	96	94	89	85	87	79	69	62	90
	80	95	92	86	83	79	74	67	61	85
	60	93	88	82	80	78	74	69	64	83
	50	91	87	81	80	78	74	69	64	83
752	100	100	101	98	96	93	94	84	69	99
	80	98	99	96	93	89	84	78	71	95
	60	97	95	92	89	87	83	79	74	92
	50	97	95	92	89	87	83	79	74	92

Outlet Sound Power, L _{Wo} [dB ref 10 ⁻¹² watts]										
RPM	% WOV	1	2	3	4	5	6	7	8	L _{Wo} A
200	100	75	72	70	70	63	54	47	40	70
	80	74	71	69	70	63	54	47	40	69
	60	74	71	69	70	63	55	48	42	69
	50	74	71	69	70	64	55	49	42	70
275	100	82	78	77	75	69	61	53	45	76
	80	81	76	75	73	67	60	52	45	73
	60	80	75	74	72	67	60	53	45	73
	50	81	75	74	73	67	60	53	45	73
375	100	90	85	84	82	80	70	61	53	84
	80	88	83	83	81	75	68	60	52	81
	60	88	82	80	79	74	68	61	53	80
	50	88	82	80	79	74	68	61	54	79
525	100	94	93	92	89	88	81	72	64	92
	80	93	91	89	87	82	76	69	62	88
	60	91	88	87	84	81	76	70	64	86
	50	93	89	86	84	80	76	70	65	86
752	100	98	101	103	100	96	95	86	73	102
	80	98	99	100	97	93	88	81	73	98
	60	97	97	97	94	90	86	80	74	96
	50	98	98	97	94	90	86	81	75	96

Performance certified is for installation type B: Free inlet, Ducted outlet. Power rating (Bhp) does not include transmission losses. Performance ratings do not include the effects of appurtenances (accessories).

The sound power level ratings shown are in decibels, referred to 10⁻¹² watts, calculated per AMCA Standard 301. Values shown are for inlet L_{Wi}, L_{Wi}A and outlet L_{Wo}, L_{Wo}A sound power levels for installation type B: Free inlet, Ducted outlet. Ratings for inlet sound do not include the effects of duct end correction. Ratings for outlet sound include the effects of duct end correction. The A-weighted sound power ratings shown have been calculated per AMCA Standard 301. The AMCA Certified Ratings Seal applies to L_{Wi}A and L_{Wo}A values only.

Performance Data		
Maximum Fan RPM	929	
Specification Data		
Maximum Motor Frame Size	405T	
Minimum Motor Starting hp	15 hp	11 kW
Wheel Diameter	66 in.	1676 mm
Approximate Weight (Less Motor & Drives)	3600 lbs.	1633 kg.
Maximum Bhp = (Fan RPM / 197) ³		
Outlet Velocity (FPM) = CFM / 30.46		
Tip Speed (FPM) = Fan RPM x 17.3		
% WOV = (CFM x 100) / (Fan RPM x 104)		

Imperial data — Metric data

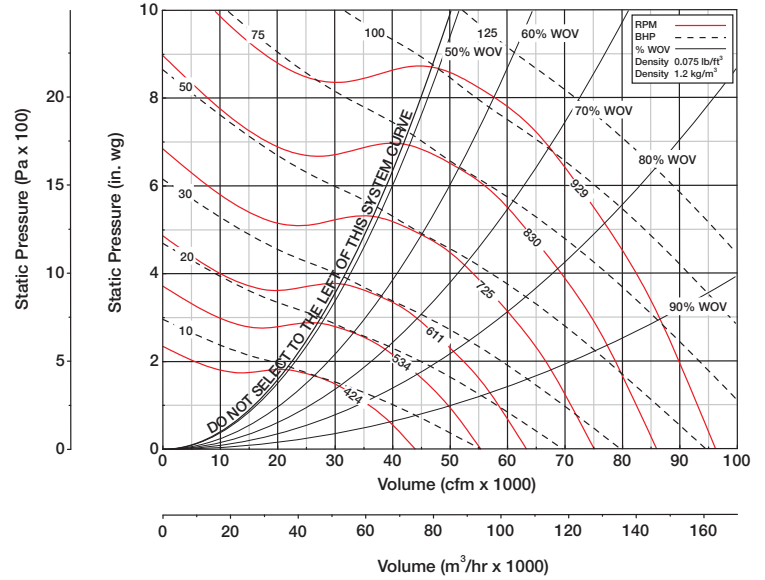

Performance Data

CFM	OV	STATIC PRESSURE (inches wg)																	
		0.5		1		2		3		4		5		6		7		8	
		RPM	BHP	RPM	BHP	RPM	BHP	RPM	BHP	RPM	BHP	RPM	BHP	RPM	BHP	RPM	BHP	RPM	BHP
33500	1105	364	4.71	407	7.61	485	14.7	562	23.0	636	32.0								
37000	1221	394	5.71	433	8.78	505	16.1	577	24.8	645	34.3	710	44.4						
40500	1336	425	6.88	460	10.1	527	17.7	592	26.7	656	36.6	719	47.2	777	58.3				
44000	1452	457	8.22	488	11.7	552	19.6	611	28.8	671	39.0	728	50.1	786	61.7	840	73.7		
47500	1567	488	9.76	516	13.4	576	21.6	632	31.1	687	41.6	743	53.1	796	65.2	849	77.7	899	90.7
51000	1683	520	11.5	546	15.4	602	23.9	655	33.6	707	44.4	759	56.2	810	68.7	859	81.8	909	95.2
54500	1798	552	13.5	577	17.6	629	26.5	680	36.5	728	47.5	775	59.5	825	72.3	872	85.9	918	99.9
58000	1914	584	15.7	608	20.0	656	29.3	704	39.5	750	50.8	796	63.2	840	76.2	887	90.1		
61500	2029	617	18.1	639	22.7	684	32.3	729	42.9	775	54.5	818	67.1	860	80.4	903	94.5		
65000	2145	650	20.9	671	25.6	712	35.7	756	46.6	800	58.5	840	71.2	881	85.0	920	99.3		
68500	2260	682	23.9	702	28.9	741	39.3	784	50.7	824	62.8	865	75.9	903	89.7				
72000	2376	715	27.2	734	32.4	771	43.3	811	55.0	850	67.4	889	80.8	926	94.9				

Shaded values show where Class I fan selections are more efficient than Class II.

		Inlet Sound Power, L _{Wi} [dB ref 10 ⁻¹² watts]									
RPM	% WOV	1	2	3	4	5	6	7	8	L _{WiA}	
275	100	81	75	72	75	69	58	50	44	74	
	80	79	72	70	71	65	55	47	38	71	
	60	77	70	68	70	64	55	47	39	70	
	50	76	69	68	70	63	55	47	39	69	
375	100	90	84	80	79	81	70	60	54	83	
	80	87	80	77	77	72	64	56	49	78	
	60	83	77	75	76	72	63	56	50	77	
	50	84	77	74	76	70	62	56	50	76	
525	100	93	92	89	87	89	82	72	63	92	
	80	91	89	87	85	81	74	67	60	86	
	60	88	85	83	82	79	74	67	61	84	
	50	90	86	82	81	78	72	67	63	83	
750	100	95	101	100	96	94	97	86	70	101	
	80	91	98	97	94	89	85	78	70	95	
	60	90	95	93	90	87	83	77	71	93	
	50	91	93	92	89	86	82	78	73	92	
929	100	97	104	105	102	99	101	95	79	106	
	80	92	99	102	100	95	92	86	77	101	
	60	93	96	98	96	92	89	84	79	98	
	50	95	96	97	95	92	89	85	80	97	

		Outlet Sound Power, L _{Wo} [dB ref 10 ⁻¹² watts]									
RPM	% WOV	1	2	3	4	5	6	7	8	L _{WoA}	
275	100	84	78	77	78	71	61	54	47	78	
	80	84	77	76	76	68	59	51	44	76	
	60	83	75	74	76	68	59	51	44	75	
	50	83	75	73	76	67	58	51	45	75	
375	100	88	85	85	82	81	71	61	54	84	
	80	88	84	83	81	75	67	59	51	82	
	60	88	82	81	80	74	66	59	52	80	
	50	88	81	79	79	73	65	59	53	79	
525	100	93	93	94	90	89	83	73	64	93	
	80	90	90	91	88	83	77	69	60	89	
	60	88	87	88	85	81	75	68	62	87	
	50	91	88	87	85	80	74	68	63	86	
750	100	96	99	103	99	96	97	87	73	103	
	80	93	96	101	98	93	88	81	72	99	
	60	94	94	97	95	90	86	79	73	96	
	50	97	96	98	94	90	84	79	74	96	
929	100	100	104	108	105	101	102	96	82	108	
	80	97	101	105	104	98	94	88	79	105	
	60	99	99	102	100	96	91	86	79	101	
	50	101	102	103	100	95	91	85	80	101	

Performance certified is for installation type B: Free inlet, Ducted outlet. Power rating (Bhp) does not include transmission losses. Performance ratings do not include the effects of appurtenances (accessories).

The sound power level ratings shown are in decibels, referred to 10⁻¹² watts, calculated per AMCA Standard 301. Values shown are for inlet L_{Wi}, L_{WiA} and outlet L_{Wo}, L_{WoA} sound power levels for installation type B: Free inlet, Ducted outlet. Ratings for inlet sound do not include the effects of duct end correction. Ratings for outlet sound include the effects of duct end correction. The A-weighted sound power ratings shown have been calculated per AMCA Standard 301. The AMCA Certified Ratings Seal applies to L_{WiA} and L_{WoA} values only.

Performance Data		
Maximum Fan RPM	680	
Specification Data		
Maximum Motor Frame Size	405T	
Minimum Motor Starting hp	15 hp	11 kW
Wheel Diameter	73 in.	1854 mm
Approximate Weight (Less Motor & Drives)	3500 lbs.	1588 kg.
Maximum Bhp = (Fan RPM / 167) ³		
Outlet Velocity (FPM) = CFM / 37.23		
Tip Speed (FPM) = Fan RPM x 19.1		
% WOV = (CFM x 100) / (Fan RPM x 159)		

Imperial data — Metric data

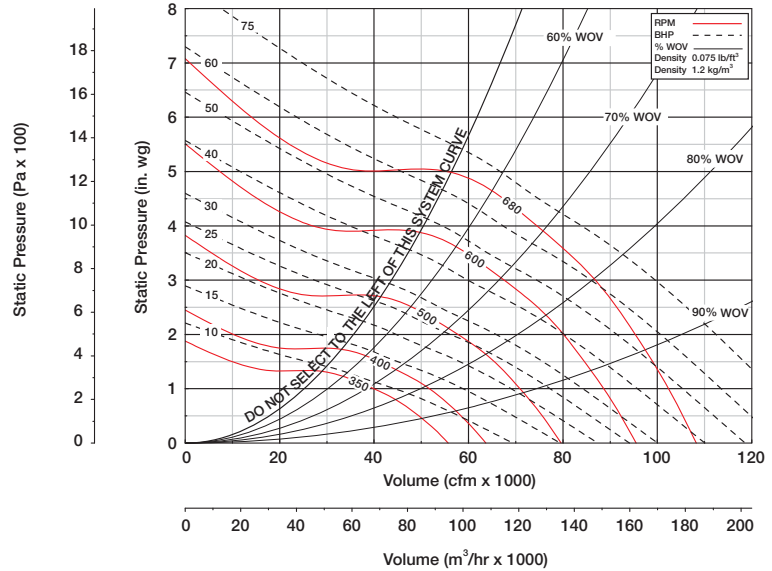

Performance Data

CFM	OV	STATIC PRESSURE (inches wg)																	
		0.25		0.5		1		1.5		2		2.5		3		3.5		4	
		RPM	BHP	RPM	BHP	RPM	BHP	RPM	BHP	RPM	BHP	RPM	BHP	RPM	BHP	RPM	BHP	RPM	BHP
34000	912	242	2.43	271	3.92	328	7.58	380	11.7										
40000	1073	276	3.36	300	4.98	349	8.89	397	13.4	439	18.2	484	23.7						
46000	1234	310	4.56	331	6.33	374	10.5	417	15.3	458	20.5	494	26.0	534	32.1				
52000	1395	345	6.06	364	8.00	402	12.4	440	17.4	477	23.1	514	29.0	547	35.1	580	41.6	615	48.8
58000	1556	381	7.89	398	10.0	432	14.7	465	20.0	500	25.8	533	32.2	566	38.8	596	45.5	625	52.5
64000	1717	417	10.1	432	12.4	463	17.4	493	22.9	525	29.0	556	35.6	586	42.6	616	49.9	644	57.2
70000	1878	454	12.7	467	15.3	495	20.5	523	26.3	551	32.6	580	39.4	609	46.7	636	54.4	663	62.3
76000	2039	490	15.8	502	18.5	529	24.2	555	30.3	579	36.7	606	43.8	632	51.3	659	59.2		
82000	2200	527	19.4	538	22.3	562	28.3	586	34.7	610	41.5	634	48.7	659	56.5				
88000	2361	564	23.5	575	26.6	597	33.0	619	39.7	642	46.8	663	54.3						
94000	2522	601	28.2	611	31.5	631	38.3	652	45.3	673	52.7								
100000	2683	638	33.5	647	37.0	666	44.2												

Inlet Sound Power, L _{Wi} [dB ref 10 ⁻¹² watts]										
RPM	% WOV	1	2	3	4	5	6	7	8	L _{Wi} A
300	100	85	81	78	78	73	63	56	51	78
	80	83	79	77	75	69	62	55	49	76
	60	82	77	76	75	69	63	56	49	75
	50	81	77	76	75	69	63	56	49	75
400	100	92	89	84	82	83	72	64	58	86
	80	91	86	82	80	76	70	63	57	82
	60	89	84	79	79	76	70	65	59	81
	50	89	83	79	79	75	70	65	59	81
500	100	99	96	90	87	89	79	70	63	92
	80	97	93	87	85	81	75	69	63	87
	60	95	89	83	82	80	75	70	65	85
	50	94	88	83	82	80	75	70	65	85
600	100	101	101	95	91	92	87	76	69	96
	80	99	99	93	89	86	80	74	68	92
	60	98	96	88	86	84	80	75	70	89
	50	96	95	88	86	84	80	75	70	89
680	100	103	105	99	95	94	92	81	73	100
	80	101	104	97	92	90	85	78	72	96
	60	99	101	92	89	88	84	79	74	93
	50	99	99	92	89	88	84	79	74	93

Outlet Sound Power, L _{Wo} [dB ref 10 ⁻¹² watts]										
RPM	% WOV	1	2	3	4	5	6	7	8	L _{Wo} A
300	100	86	82	82	80	75	65	57	50	80
	80	85	81	80	78	71	64	57	49	78
	60	85	79	78	77	71	65	57	49	77
	50	85	79	78	77	71	64	57	50	77
400	100	92	89	89	86	84	75	66	58	88
	80	92	87	87	84	78	72	64	56	85
	60	91	85	84	82	77	72	65	58	83
	50	91	85	84	82	77	72	65	59	83
500	100	96	94	94	91	90	82	73	65	94
	80	95	92	91	88	83	78	70	63	90
	60	93	90	89	86	82	77	71	65	88
	50	95	90	88	86	82	77	72	67	88
600	100	98	99	98	96	93	88	79	71	98
	80	98	97	95	93	88	83	76	69	94
	60	96	95	93	91	87	82	77	71	93
	50	98	96	92	90	87	82	77	72	92
680	100	100	102	101	100	96	93	84	76	102
	80	99	101	98	97	92	87	81	73	98
	60	98	99	95	95	91	87	81	75	96
	50	100	100	95	94	90	86	81	76	96

Performance certified is for installation type B: Free inlet, Ducted outlet. Power rating (Bhp) does not include transmission losses. Performance ratings do not include the effects of appurtenances (accessories).

The sound power level ratings shown are in decibels, referred to 10⁻¹² watts, calculated per AMCA Standard 301. Values shown are for inlet L_{Wi}, L_{Wi}A and outlet L_{Wo}, L_{Wo}A sound power levels for installation type B: Free inlet, Ducted outlet. Ratings for inlet sound do not include the effects of duct end correction. Ratings for outlet sound include the effects of duct end correction. The A-weighted sound power ratings shown have been calculated per AMCA Standard 301. The AMCA Certified Ratings Seal applies to L_{Wi}A and L_{Wo}A values only.

Performance Data		
Maximum Fan RPM	840	
Specification Data		
Maximum Motor Frame Size	405T	
Minimum Motor Starting hp	15 hp	11 kW
Wheel Diameter	73 in.	1854 mm
Approximate Weight (Less Motor & Drives)	4200 lbs.	1905 kg.
Maximum Bhp = (Fan RPM / 167) ³		
Outlet Velocity (FPM) = CFM / 37.23		
Tip Speed (FPM) = Fan RPM x 19.1		
% WOV = (CFM x 100) / (Fan RPM x 140)		

Imperial data — Metric data

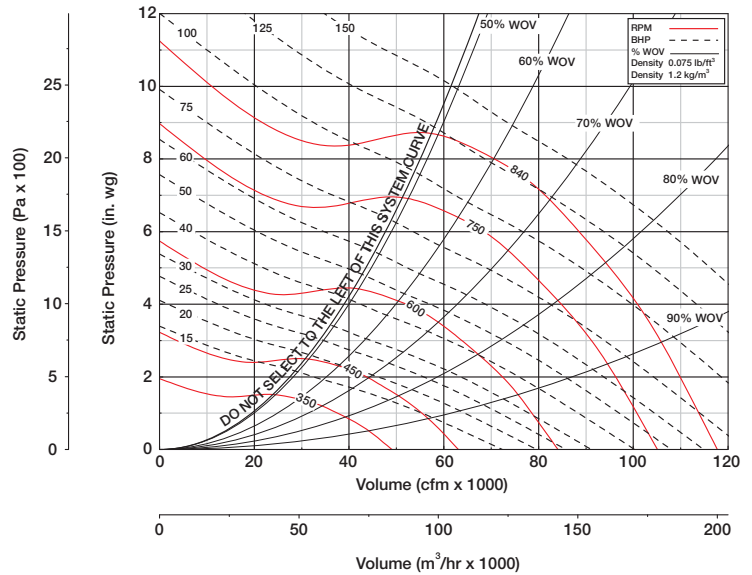

Performance Data

CFM	OV	STATIC PRESSURE (inches wg)																	
		0.5		1		2		3		4		5		6		7		8	
		RPM	BHP	RPM	BHP	RPM	BHP	RPM	BHP	RPM	BHP	RPM	BHP	RPM	BHP	RPM	BHP	RPM	BHP
40000	1073	323	5.51	362	9.20	436	17.6	507	27.6	573	38.5								
45000	1207	355	6.91	390	10.6	455	19.6	520	30.2	583	41.8	641	54.1						
50000	1341	388	8.58	418	12.6	479	21.9	537	32.9	595	45.1	651	58.1	704	71.7				
55000	1476	421	10.6	448	14.8	504	24.6	557	35.9	611	48.6	662	62.3	713	76.6	762	91.5		
60000	1610	454	12.9	479	17.4	531	27.6	580	39.3	628	52.4	678	66.6	724	81.7	772	97.2	817	113.4
65000	1744	488	15.5	511	20.4	559	31.1	605	43.2	651	56.6	694	71.1	740	86.7	783	103.1	827	119.9
70000	1878	522	18.6	543	23.8	588	35.0	631	47.5	674	61.3	715	76.2	757	92.1	799	109.1	839	126.7
75000	2012	556	22.0	576	27.5	617	39.3	658	52.2	699	66.5	738	81.8	776	98.1	815	115.3		
80000	2147	591	25.9	610	31.8	647	44.1	687	57.6	724	72.2	762	87.8	799	104.6	834	122.1		
85000	2281	625	30.3	643	36.5	678	49.4	715	63.4	751	78.3	787	94.5	822	111.5				
90000	2415	660	35.2	677	41.7	710	55.3	745	69.8	779	85.1	813	101.7						
95000	2549	695	40.7	711	47.5	742	61.7	774	76.7	808	92.6	840	109.3						

Shaded values show where Class I fan selections are more efficient than Class II.

Inlet Sound Power, L _{Wi} [dB ref 10 ⁻¹² watts]										
RPM	% WOV	1	2	3	4	5	6	7	8	L _{Wi} A
300	100	86	80	77	78	76	64	56	49	79
	80	83	77	75	75	69	60	52	44	75
	60	81	74	73	75	68	59	52	45	74
	50	80	73	72	74	67	59	52	45	74
450	100	95	90	88	86	89	79	70	61	91
	80	93	87	86	84	79	72	65	58	85
	60	90	83	82	82	78	72	65	59	83
	50	91	84	81	81	77	70	65	61	82
600	100	96	98	96	93	93	91	80	66	98
	80	94	95	94	91	86	81	73	66	92
	60	91	91	90	88	84	79	73	67	90
	50	92	91	89	87	83	78	74	69	89
750	100	98	103	103	99	97	99	89	73	104
	80	95	101	100	96	92	88	81	72	98
	60	93	97	96	93	90	86	80	74	95
	50	94	97	95	92	89	85	81	76	95
840	100	100	105	106	102	100	101	94	78	107
	80	96	102	103	100	95	91	85	76	101
	60	95	99	99	96	93	89	84	78	99
	50	97	100	98	95	92	89	84	79	98

Outlet Sound Power, L _{Wo} [dB ref 10 ⁻¹² watts]										
RPM	% WOV	1	2	3	4	5	6	7	8	L _{Wo} A
300	100	87	82	82	81	77	66	58	51	82
	80	86	81	81	80	72	64	55	48	80
	60	86	79	78	80	71	63	56	49	79
	50	86	78	77	79	70	62	56	49	78
450	100	93	92	93	89	89	80	71	62	92
	80	91	89	91	87	82	75	66	58	88
	60	90	87	88	85	80	73	66	60	86
	50	92	87	87	84	79	72	67	61	85
600	100	96	98	100	96	94	92	81	69	99
	80	93	95	98	94	89	84	76	67	96
	60	93	93	95	91	87	81	75	69	93
	50	95	94	95	91	86	80	75	70	92
750	100	99	102	105	103	99	99	90	76	105
	80	96	99	104	101	96	91	83	75	102
	60	97	98	100	98	93	88	82	76	99
	50	99	100	100	97	92	87	82	77	99
840	100	101	104	107	106	102	102	95	81	108
	80	98	101	105	104	99	95	88	79	105
	60	99	101	102	101	96	92	86	79	102
	50	102	104	103	101	96	91	86	81	102

Performance certified is for installation type B: Free inlet, Ducted outlet. Power rating (Bhp) does not include transmission losses. Performance ratings do not include the effects of appurtenances (accessories).

The sound power level ratings shown are in decibels, referred to 10⁻¹² watts, calculated per AMCA Standard 301. Values shown are for inlet L_{Wi}, L_{Wi}A and outlet L_{Wo}, L_{Wo}A sound power levels for installation type B: Free inlet, Ducted outlet. Ratings for inlet sound do not include the effects of duct end correction. Ratings for outlet sound include the effects of duct end correction. The A-weighted sound power ratings shown have been calculated per AMCA Standard 301. The AMCA Certified Ratings Seal applies to L_{Wi}A and L_{Wo}A values only.

Specifications

Model QEI and QEID

Supply, exhaust, or return air fans shall be of the inline mixed flow type.

The housing shall be constructed of welded heavy-gauge steel to assure no air leakage. Housing shall have inlet and outlet collars for slip-fit duct connections. The housing and bearing and/or motor supports shall be constructed of heavy-gauge steel members to prevent vibration and rigidly support the shaft and bearings. Welded steel vanes shall straighten the flow of air from the fan discharge.

All QEI units up through size 27 shall incorporate a universal mounting system that allows the fan to be mounted in either vertical or horizontal configurations and field rotation of the motor position in 90 degree increments. Bearing life shall not be reduced below specified level in different configurations. QEI units size 30 and larger shall allow for field rotation of motor positions. Units shall accommodate base mount or ceiling hung mounting without structural modifications to the fan.

The wheel shall be of the mixed flow type. Wheels shall have a wheel cone, spherical back plate and single thickness cambered blades. Wheels shall be statically and dynamically balanced to balance grade G6.3 per ANSI S2.19. The wheel cone and fan inlet cone shall be carefully matched and shall have precise running tolerances for maximum performance and operating efficiency.

Each assembled fan shall be test run at the factory at the specified fan RPM. The maximum allowable fan vibration shall be 0.15 in/sec. peak velocity, filter-in for QEI with signatures taken on each bearing in three planes; horizontal, vertical, and axial. Maximum vibration of 0.08 in/sec. peak velocity, filter-in for QEID in a single plane on the fan housing. This report shall be provided at no charge to the customer upon request.

Inlet and outlet sound power levels shall be provided for each of the eight octave bands at the point of operation.

Fans shall be licensed to bear the AMCA Seal for Sound and Air Performance.

Mixed flow fans shall be Model QEI or QEID as manufactured by Greenheck Fan Corporation, Schofield, Wisconsin, USA and shall be supplied as shown on the plans and in the fan schedule.

Additional Belt Drive Specification

Turned, precision ground and polished steel shafts shall be sized so the first critical speed is at least 25% over the maximum operating speed. Close tolerances shall be maintained where the shaft makes contact with the bearings.

Bearings shall be heavy-duty, grease lubricated, self-aligning ball or roller type with extended lubrication lines. QEI bearings shall be selected for a minimum life L_{10} of 80,000 (L_{50} of 400,000) hours at maximum operating speed.



Our Commitment

As a result of our commitment to continuous improvement, Greenheck reserves the right to change specifications without notice.

Specific Greenheck product warranties are located on greenheck.com within the product area tabs and in the Library under Warranties.



Prepared to Support
Green Building Efforts

