

MUFFAN

Filtered Make-up Fresh Air Fans

PRODUCT GUIDE



PENNBARRY™

TABLE OF CONTENTS

INTRODUCTION	3
CERTIFICATIONS & LISTINGS	4
FEATURES & BENEFITS	5-6
OPTIONS AND ACCESSORIES	7-8
DIMENSIONS MU DIRECT DRIVE	9
DIMENSIONS MU BELT DRIVE	10
DIMENSIONS FS BELT DRIVE	11
FAN SELECTIONS	12-13

INTRODUCTION

Direct Drive Units

PennBarry's Muffan replaces foul or contaminated air that is removed by a building's exhaust system.

Such make-up air is so essential that it is part of safety and building code requirements for commercial kitchens, chemical laboratories, electrical control rooms and anywhere gas equipment is installed. Proper make-up air provisions should be part of every building plan.

Without adequate make-up air, air starvation can create negative pressures within a structure. Doors open with difficulty. Dirt, insects, and debris are drawn in through entrances. Fumes and odors accumulate. Pilot lights operate erratically. Moisture is sucked in through cracks in roofs and walls and around windows and doors. Air becomes stale. Backdrafts occur. Air handling systems operate ineffectively, inefficiently, and expensively. Heated or cooled air is wasted when make-up air is not properly considered.

On the other hand, uncontrolled airflow through windows and doors creates drafts, lets heat escape, and admits moisture, dust, dirt, and pollen.

The Muffan's ability to regulate airflow ensures proper replacement air volume under varying conditions. The Muffan can be coordinated to match the exhaust velocity required to remove fumes, vapors, and grease while providing sufficient oxygen, thus feeding the system effectively.

Belt Drive Units

Larger belt drive models extend the range of the Muffan. Now, clean air volumes approaching 14,000 CFM can be supplied to replace exhausted air and fumes.

Blowers are of an efficient, double inlet, forward-curved design in strong, die-formed steel housings. Variable pitch pulleys allow adjustment in RPM for more precise regulation of airflow. Motors, belts, pulleys and other components form a dependable, durable and quiet-operating assembly, easily balanced to meet system requirements.

MU Models

The housing's louvered sides permit a direct air path, giving the housing a low profile to the roof. Cleanable, permanent filters back-up each louvered side to prevent airborne contaminants from entering. Filters are easily removed for cleaning.

An integral mounting base permits easy installation on a roof curb. Roof curbs speed, simplify, and coordinate installation of roof-mounted supply and exhaust equipment. PennBarry offers an extensive variety of curbs for mounting on flat and sloped roofs.



Muffan Model MU

Model: MU

- Static pressure up to 1.0" wg.
- Direct Drive - Flow capacity up to 3,730 CFM
- Belt Drive - Flow capacity up to 14,426 CFM



Muffan Model FS

Model: FS - Side Intake

- Static pressure up to 1.5" wg.
- Belt Drive - Flow capacity up to 12,721 CFM

CERTIFICATIONS & LISTINGS



AMCA Certification

PennBarry certifies that the Muffan models shown on page 10 are licensed to bear the AMCA Seal. The ratings shown are based on tests and procedures performed in accordance with AMCA Publication 211 and comply with the requirements of the AMCA Certified Ratings Program. Excluding MU6020 and direct drive models.



cULus Certification

All Muffan fans carry the UL label, UL705 (ZACT/ZACT7), file #E28413.

High Velocity Hurricane Zone (HVHZ), Miami-Dade NOA #17-0112.08, Florida Product Approval #21559

FEATURES & BENEFITS

Washable Filters

The unit is designed to handle 1" or 2" filters by utilizing tabs in the filter tracks. The filter media is washable aluminum available with a 1" or 2" inch thickness.

Easy Installation

The base/curb cap is free of protruding fasteners which would interfere with installation onto the curb.

Easy Maintenance Access

A full-size insulated (FS Model only) cover is easily removed via adjustable heavy duty, quick-release latches, providing clear access to all components. The gasket is installed in the cover, not the housing, so it is not damaged during maintenance.

Structural Integrity

The galvanized housing provides a high degree of rigidity and weather protection by bending and overlapping all seams. Additional angle reinforcement is provided along the interior base, providing stiffness to the walls and support of the unit on the curb. The housing cover is gasketed with thick closed-cell neoprene and "pitched" to ensure complete rain run-off.

Conduit Entry

A large 1" diameter hole in the base provides ample room to easily run electrical power into the housing.

Internal Wiring

All direct drive models feature a polarized disconnect plug which is factory wired from the motor to the junction box. This provides a positive method of electric shut-off as required by most codes without requiring the traditional disconnect switch. Internal wiring can be added as an option to belt driven units. (See "Safety Service Switch" for optional disconnect devices.)

Vibration Isolators

The blower housing/motor assembly uses multi-directional, rubber-in-shear isolators to mitigate residual vibrations transmission from the unit to the building.

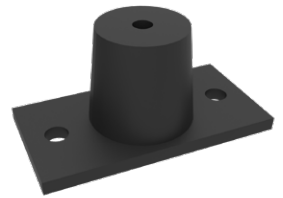

Intake Hood (Model FS Only)

The intake hood is sloped and properly sized for low velocity, preventing water entry. The 1" aluminum filters are washable and secured by easy-to-use thumb latches. If a longer intake hood is desired, an optional extension is available for selection.

Motor Selection

Available in a wide range of voltages and enclosures, high quality open drip proof motors are standard.

After choosing a fan model from the Direct Drive or Belt Drive Performance Data sections, it is important to review the motor availability charts in this section before specifying electric motors for your particular needs. Factors which influence the selection process are discussed below.

Electric Power Considerations

First, determine the nature of the electric power feeding the motor. Is it single phase or three phase power? Next, determine the required line voltage. Is it 115V, 230V, or 460V? If your HVAC application is in the U.S., the frequency of the alternating current will be 60 Hz. All of North America and most of Central and South America use 60 Hz, as does Saudi Arabia. Most other countries in the world use 50 Hz.

FEATURES & BENEFITS

High-Efficiency Motors

High-efficiency motors that comply with the requirements of the Energy Policy Act of 1992 are available.

Drives and Belts

Pulleys are pre-set to the specified RPM. Cast iron variable pitch pulleys are adjustable, allowing for field balancing based on actual field conditions. All pulleys are sized for at least 150% of the driven horsepower. Motors can be adjusted to maintain proper belt tension.

OPTIONS AND ACCESSORIES

Safety Service Switch

Safety service switches are available to allow positive electrical shut-off and safety. Switches are factory mounted when factory wiring is requested. Wiring is only run from the motor to the junction box. (Factory wiring of explosion proof applications is not available.) A wide range of Nema rated enclosures with service switches are available for indoor, outdoor, and explosion proof installations. Service switches are to be field wired by a licensed electrician.



Lek-Trol Speed Controllers

The Lek-Trol™ controller allows adjustment in speed to a maximum of 50% reduction, which results in a very cost effective means for system balancing. The device can be located under the motor cover to prevent unauthorized tampering or on the wall for ease of operation by the building occupants. (Available on direct drive units with ODP motors.)



Firestat Switch

Firestat switch automatically disconnects the unit when the temperature of the air being supplied exceeds a preset rating



Dampers

Dampers are available for either counter balanced or motorized operation (motor kit optional). Dampers feature square galvanized steel frames, and multi-leaf, roll formed aluminum blades with nylon bearings.



Finishes

Coatings such as Polyester Powder Coat, Epoxy Powder Coat, Phenolic Epoxy Powder Coat, and others are available. See the coatings brochure for details.

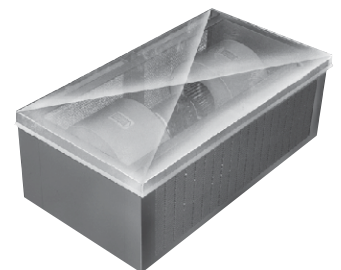

Muffan Model MU, Direct Drive

OPTIONS AND ACCESSORIES

Prefabricated Curb

A variety of sizes of prefabricated roof curbs are available. Galvanized steel unibeam curbs are the most popular. For a complete listing of all curb types and sizes available, see the latest PennBarry Ventilation Curb brochure. Please, note that NFPA 96 installations require a specific curb height.

Pedestal

The 12" high mounting pedestal, available in aluminum or galvanized steel, incorporates a removable access panel for easy inspection and service of motor operated backdraft dampers. It provides solid ventilator support and a weather resistant seal that does not injure or disturb flashing.

Spare Belt

An extra set of one or two spare belts is an available selection.

Variable Frequency Drives

Variable frequency drives (VFDs) are designed to meet performance requirements while increasing efficiency. By varying the fan motor input frequency and voltage, the VFD controls the motor speed and torque, helping to improve productivity and lower energy consumption. The VSC and VSA are ideal for both new and retrofit fan applications. Shipped loose and separately.

High Wind Construction

High wind construction MU fans are specifically designed for high velocity hurricane zones (HVHZ). The MU models are designed to withstand 150 MPH winds in accordance with Miami-Dade and Florida Building Code standards. The units are 3rd party tested and certified through a 3rd party Professional Engineer (P.E.) to meet these strict standards. Installation details are provided, and since there are no tie downs or external braces required for attaching the unit to the roof or curb, this makes installation simple and easy. A wide range is offered to meet all of your ventilation needs which includes all belt and direct drive sizes.

DIMENSIONS | MU DIRECT DRIVE

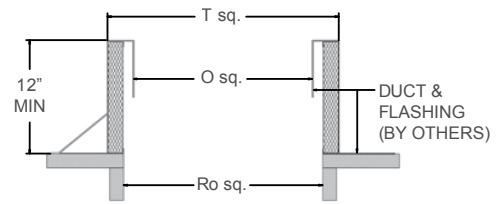
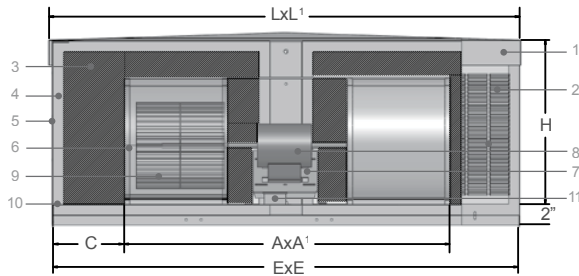

- | | |
|--|--|
| <ol style="list-style-type: none"> 1. Removable Roof Cap 2. Louvered Side Panels 3. Removable 1" Thick Cleanable Filters 4. Filter Track 5. Solid End Panels 6. Blower Housings with Support Bar | <ol style="list-style-type: none"> 7. Motor and Blower Housing Mounting Plates 8. Resilient Mounted Ball Bearing Motor (Thermally Protected) 9. Centrifugal Blower Wheels 10. Integral Mounting Base 11. Service Switch |
|--|--|

Model	Dimensional Data							Filters		Self-Flashing Aluminum Curb			Unibeam or Field Built Curb (UNI-12)			Ship Wt. (lbs)
	L	L ¹	H	C	A	A ¹	ExE	Qty	Size	RoxRo1	OxO1	TxT1	RoxRo1	OxO1	TxT1	
MU10	25	21	16	4 $\frac{3}{8}$	16 $\frac{1}{4}$	4 $\frac{1}{4}$	25x19	2	16x20	21 $\frac{1}{2}$ x 15 $\frac{1}{2}$	21 $\frac{1}{2}$ x 15 $\frac{1}{2}$	34 $\frac{1}{2}$ x 18 $\frac{1}{2}$	20 $\frac{1}{2}$ x 14 $\frac{1}{2}$	20 $\frac{1}{2}$ x 14 $\frac{1}{2}$	23 $\frac{1}{2}$ x 17 $\frac{1}{2}$	75
MU20	43	22	16	6 $\frac{1}{2}$	30	4 $\frac{1}{4}$	43x20	4		39 $\frac{1}{2}$ x 16 $\frac{1}{2}$	39 $\frac{1}{2}$ x 16 $\frac{1}{2}$	42 $\frac{1}{2}$ x 19 $\frac{1}{2}$	38 $\frac{1}{2}$ x 15 $\frac{1}{2}$	38 $\frac{1}{2}$ x 15 $\frac{1}{2}$	41 $\frac{1}{2}$ x 8 $\frac{1}{2}$	230
MU30	43	22	16	3	37	6 $\frac{1}{8}$	43x20			39 $\frac{1}{2}$ x 16 $\frac{1}{2}$	39 $\frac{1}{2}$ x 16 $\frac{1}{2}$	42 $\frac{1}{2}$ x 19 $\frac{1}{2}$	38 $\frac{1}{2}$ x 15 $\frac{1}{2}$	38 $\frac{1}{2}$ x 15 $\frac{1}{2}$	41 $\frac{1}{2}$ x 8 $\frac{1}{2}$	240

All dimensions in inches.

DIMENSIONS | MU BELT DRIVE

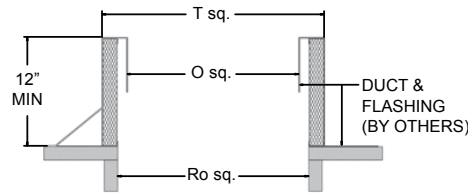
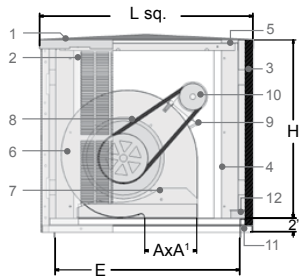

MU3010 to MU5018 (left) and MU6020 (right)

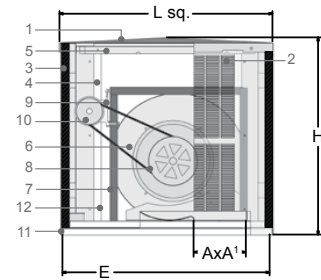

- | | |
|---|------------------------------------|
| 1. Removable Roof Cap | 7. Blower Housing Mounting Angles |
| 2. Louvered Side Panels | 8. Belt and Pulleys |
| 3. Removable 1" (2" for MU6020) Thick Cleanable Filters | 9. Adjustable Motor Mounting Plate |
| 4. Filter Track | 10. Motor |
| 5. Angle Reinforcing Supports | 11. Mounting Base |
| 6. Blower Housing | 12. Service Switch |

Model	Dimensional Data					Filters		Self-Flashing Aluminum Curb			Unibeam or Field Built Curb (UNI-12)			Ship Wt. (lbs)
	L	H	A	A¹	E	Qty	Size	RoxRo¹	OxO¹	TxT¹	RoxRo¹	OxO¹	TxT¹	
MU3010	28½	24	11½	13½	22½	4	20 x 25	19	19	22	18	18	21	100
MU4012	36½	27	13 ⅞	15½	27½	4	20 x 25	24	24	27	23	23	26	160
MU4015	36½	27	15½	18½	27½	4	20 x 25	24	24	27	23	23	26	180
MU5018	45	27	19½	22½	31	8	20 x 25	27 ½	27 ½	30 ½	26 ½	26 ½	29 ½	310
MU6020	58½	47	24½	24½	58	16	20 x 25	54 ½	54 ½	57 ½	53 ½	53 ½	56 ½	770

All dimensions in inches.

DIMENSIONS | FS BELT DRIVE

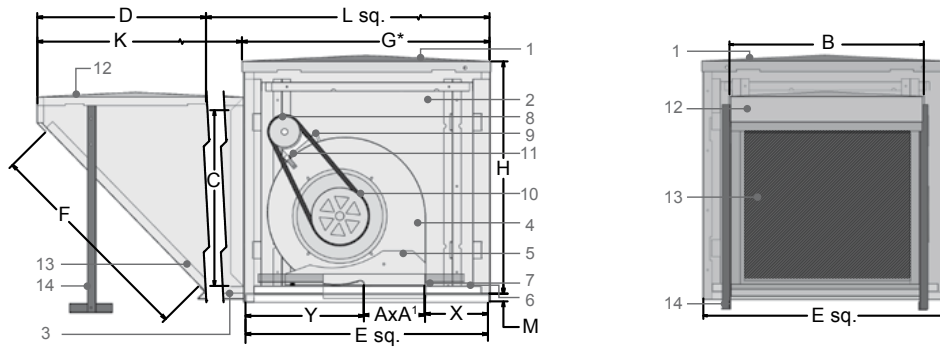

- 1. Removable Roof Cap with Gasket
- 2. Galvanized Steel Housing
- 3. Integral Mounting Base
- 4. Blower Housing
- 5. Blower Housing Mounting Plates
- 6. Steel Angle Cross Braces
- 7. Anti-vibration Mounts
- 8. Thermally Protected Motor
- 9. Safety Disconnect Switch
- 10. Belt and Pulleys
- 11. Adjustable Motor Mounting Plate
- 12. Filter Hood (Optional Extension)
- 13. Cleanable Filters
- 14. Hood Support Angles with Feet

Model	E* Sq.	Ro Sq.	L Sq.	H	Y	Outlet A x A1		X	Inlet Duct		D	F	G**	K	M	Qty/Size (WxH) of Filters
						C	B		C	B						
FS10B	28 3/8	20	28 7/8	27 1/8	8	11 1/2	13	8 7/8	22 1/2	22 7/8	23 3/8	27 1/8	120	19 3/8	2	(1) 21 1/2 x 26 1/4
FS12B	32 3/8	24	32 7/8	31 3/8	8 3/8	13 1/2	15 1/2	10 1/4	26 3/4	26 7/8	27 3/4	33 3/8	120	23 3/8	2	(1) 25 3/4 x 32 1/4
FS15B	32 3/8	24	32 7/8	31 3/8	7 1/2	15 7/8	18 3/8	9	26 3/4	26 7/8	27 3/4	33 3/8	120	23 3/8	2	(1) 25 3/4 x 32 1/4
FS18B	36 3/8	28	36 7/8	35 1/8	6 3/8	18 7/8	21 3/4	10 3/8	30 1/2	30 3/8	31 3/8	38 1/2	120	27 1/4	2 1/2	(2) 18 3/4 x 29 1/2
FS20B	48 3/8	40	48 7/8	52 3/8	11 7/8	24 7/8	24 3/4	12 3/8	42	42 3/8	43	54 3/8	120	38 3/4	3 1/2	(2) 26 7/8 x 41

All dimensions in inches. *Outside dimension of curb should be 1 1/2" less than 'E' dimension. ** With optional extension only.

FAN SELECTIONS

Model

FS = Muffan Side Intake Filtered Make-up Fresh Air Fan

MU = Muffan Filtered Make-up Fresh Air Fan

Construction

<p>Application Flow (CFM) <enter value></p> <p>Application Static Pressure (inwg) <enter value></p>	<p>Drive Type B = Belt D = Direct</p> <p>Fan RPM <####></p>	<p>Unit Size 10, 12, 15, 18, 20, 30, 3010, 4012, 4015, 5018</p>
---	---	---

Motor

<p>Efficiency P = Premium S = Standard</p> <p>Horsepower 0.125 = 1/8 0.250 = 1/4 0.333 = 1/3 0.500 = 1/2 0.750 = 3/4 01.00 = 1 01.50 = 1 1/2 02.00 = 2 03.00 = 3 05.00 = 5 07.50 = 7 1/2 X = Special</p>	<p>Motors and Drives F = Factory mounted L = Less motor and drive M = Less motor less drive</p> <p>Motor Enclosure 0 = None 1 = TE w/Overload 2 = TE w/o Overload 3 = ODP w/Overload 4 = ODP w/o Overload X = Special</p> <p>Voltage/Phase/Cycle B = 110V/1PH/50HZ* C = 115V/1PH/60HZ D = 120V/1PH/60HZ* F = 208V/1PH/60HZ G = 208V/3PH/60HZ</p>	<p>H = 220V/1PH/50HZ* J = 220V/3PH/50HZ* K = 230V/1PH/60HZ L = 230V/3PH/60HZ M = 240V/1PH/50HZ* N = 240V/3PH/50HZ* P = 277V/1PH/60HZ*# Q = 380V/3PH/50HZ* R = 380V/3PH/60HZ* S = 400V/3PH/50HZ* T = 415V/3PH/50HZ* U = 440V/3PH/50HZ* V = 460V/3PH/60HZ W = 480V/3PH/60HZ* X = Special Y = 575V/3PH/60HZ * Non-standard offering subject to longer lead times and price adjustment # 277V applications require a transformer</p>
--	--	--

Electrical Accessories

<p>Controllers 0 = None 1 = Lek-Trol SCR speed controller (mounted). 2 = Lek-Trol SCR speed controller (loose). V = VFD (belt drive only) Note: VFD can be ordered separately</p>	<p>Service Switches and ITW* 0 = None 1 = NEMA 1 ITW only 3 = NEMA 3R ITW only A = NEMA 1 - loose C = NEMA 1 - mounted and wired D = NEMA 3R - loose F = NEMA 3R - mounted and wired G = NEMA 4 - loose X = Special</p>	<p>* ITW - Internal wiring not provided on explosion proof motors</p> <p>Switches / Sensors 0 = None F = Firestat switch</p>
---	---	--

FAN SELECTIONS

Options and Accessories

Construction Accessories

0 = None
K = Intake extension (FS Only)

Curb

0 = None
C = Curb
Note: Curbs ordered separately on all PLOPs

Damper

0 = None
D = Damper
X = Special

Filters

0 = None
A = 1" Washable Aluminum Filters
B = 2" Washable Aluminum Filters

Paint/Coating

0 = None
F = Epoxy powder coat (light gray)
G = Epoxy powder coat with UV protection (gray)
K = Phenolic epoxy powder coat (gray)
L = Phenolic epoxy powder coat with UV protection (gray)
N = Polyester powder coat*
X = Special
* Colors only available in Polyester Powder Coat

Paint Color*

00 = None
50 = Chrome green
55 = Pale green
56 = Dove gray (PPC standard)
61 = White
63 = Oxford beige
65 = Dover white
66 = Desert tan
70 = Black

73 = Smoke gray
77 = Brick red
79 = Peppercorn
81 = Pale brown
83 = Chocolate brown
85 = Timeless bronze
94 = Charcoal
X = Special
* Colors only available for polyester powder coat

Pedestal

0 = None
E = Side discharge galvanized

Spare Belt(s)

0 = None
1 = 1 spare set
2 = 2 spare set

Special Construction

0 = None
H = High wind (Maimi-Dade)

PENNBARRY PRODUCT SOLUTIONS



Commercial

- Roof & wall exhaust centrifugal fans
- Ceiling, wall, & inline centrifugal fans
- Roof supply centrifugal fans
- Square & round centrifugal fans
- Wall mounted axial fans
- Hooded roof axial fans
- Upblast roof axial fans
- Gravity ventilators
- Roof curbs



Industrial

- Freestanding centrifugal fans
- Industrial & material handling fans
- Tubular centrifugal inline fans
- Mixed flow centrifugal fans
- Plug & plenum fans
- Wall mounted propeller fans
- Tube axial fans
- Vane axial fans
- Bifurcator fans
- Lab exhaust



Kitchen ventilation

- Make-up air units
- Exhaust fans



Energy recovery

- Outdoor units
- Indoor units

PennBarry is proud to be your preferred manufacturer of commercial and industrial fans and blowers. Learn how PennBarry can assist you in your next application by contacting your PennBarry Representative or visiting us on the web at www.pennbarry.com

PennBarry | www.pennbarry.com | pennbarrysales@pennbarry.com | Tel 972 212 4700 | Fax 972 212 4702

PennBarry reserves the right to make changes at any time, without notice, to models, construction, specifications, options and availability. This document illustrates the appearance of PennBarry products at the time of publication. View the latest updates on the PennBarry website.

© 2018 PennBarry. All rights reserved. MUFFAN SEPTEMBER 2018.



PENNBARRY™